

2019 SUPER DUTY®



XL | XLT | LARIAT | KING RANCH® | PLATINUM | LIMITED



**“HIGHEST RANKED
LARGE HEAVY DUTY PICKUP
IN INITIAL QUALITY”¹**
— J.D. Power, 2018

¹The Ford Super Duty received the lowest rate of reported problems (tie) among Large Heavy Duty Pickups in the J.D. Power 2018 U.S. Initial Quality Studies of new vehicle owners' experience with their own vehicle after 90 days of ownership. Visit jdpower.com/awards.

SUPER DUTY LIKE NO OTHER

This beast is something special. “What a workhorse,” says *Motor Trend*. Its name – stamped front and center. And Super Duty only gets tougher from there. This year, a new F-450 Regular Cab 4x2 hits the ground towing a best-in-class¹ 35,000 lbs.² A new LARIAT Sport Package³ on 4x4 Crew Cab models delivers your gear to the trailhead in style with blacked-out exterior trim and black-painted aluminum wheels.

Inside, a new specially tuned, 1,000-watt B&O PLAY™ Premium Audio System by HARMAN⁴ gets the cabin rocking like never before. While a new FordPass™ Connect 4G LTE Wi-Fi hotspot^{4,5} lets you – and the crew – connect up to 10 devices.

As America’s best-selling truck for 41 years, Ford F-Series helps you finish jobs others won’t even start. From F-250 to F-450, in work-ready XL to fully loaded LIMITED, this truck’s work ethic is legendary. The 2019 Ford Super Duty. Rock solid. Ready for duty.



2019 Super Duty® | ford.com

F-250 LARIAT Crew Cab 4x4. Magnetic. Available equipment. ¹Class is Full-Size Pickups over 8,500 lbs. GVWR based on Ford segmentation. ²When properly configured. See Towing chart in Specifications for maximum ratings by configuration. ³Available Fall 2018. ⁴Available feature. ⁵Certain restrictions, 3rd-party terms, or message and data rates may apply. See footnotes 6 and 7 on XL Features pages and your Ford Dealer for details.

Vehicles throughout this publication may be shown with optional and aftermarket upfit equipment and without standard antenna.



Imagine how much an F-Series Super Duty will haul over its lifetime. Stumps. Brush. Fence posts. Cinder blocks. Hay bales. Aggregate. Tools. Generators. Landscaping materials. Pea gravel. 5th-wheel/gooseneck trailers. This cargo box is engineered with extreme capability in mind.

It's the first and only one in its class made from high-strength, military-grade, aluminum alloys.¹ Dent-and-ding resistance inside: better than steel. Susceptibility to red rust: gone. The only thing more special is this: best-in-class max. payload can sit inside these walls.





NEW LARIAT SPORT PACKAGE! Hook up your ATVs and dirt bikes, and head out to the trailhead. Available on F-250 and F-350 LARIAT Crew Cab 4x4 SRW models, the new LARIAT Sport Package adds rear wheel-well liners, a Tough Bed® bedliner, blacked-out headlamp surrounds² plus high-gloss, black-painted grille bars, running boards, mirror caps and fender vent surrounds. 20" premium black-painted aluminum wheels complete the athletic look.

2019 Super Duty® | ford.com

F-350 LARIAT Crew Cab 4x4. Agate Black. LARIAT Sport Package. Available equipment.

¹Available Fall 2018. ²Halogen headlamps only.



THE DNA OF BFT

Built Ford Tough® is more than just a brutal testing regimen. It's a battle cry. One filled with honor, courage and determination to never rest – until the job's done right. With over 12 million cumulative miles of customer-equivalent testing logged, the all-new 2017 and successive 2019 Super Duty earned their Blue Ovals. Being tortured in the lab. On the proving grounds. And working in the real world. By running up and down steep grades. With maximum trailer weights. Then up and down again. In subzero cold. And in stifling heat. With more trucks on the road with 250,000 miles than any other brand, there's nothing tougher than Ford F-Series.¹

All Super Duty pickups have 6 airbags, including the side-curtain airbags of the Safety Canopy® System. Crew Cab models also offer class-exclusive inflatable rear safety belts² for rear outboard passengers to further enhance occupant protection.



Try to avoid water higher than the bottom of the hubs and proceed slowly.
Refer to your owner's manual for detailed information regarding driving through water.

2019 Super Duty® | ford.com

F-350 XL SuperCab 4x4. Ingot Silver. STX Appearance and FX4 Off-Road Packages. Available equipment. ¹"More trucks on the road" based on IHS Markit Vehicles in Operation (VO) data and latest odometer readings available to IHS Markit for 1992 and newer model year full-size pickups still on the road in the U.S. as of 4/1/2018. ²Available feature.



We virtually test Super Duty components in the lab, then punish vehicles at the proving grounds towing dynamometer sleds. Then on public roads and highways at temperatures from -20° to 120°F. We also put prototype models in the hands of people like you, working in some of the most demanding industries. We conduct thermal shocks that swing ambient temperature 250°F in under 2 minutes, as well as powertrain tests that replicate going up a 6% grade over 500 miles. Super Duty also endures 4-post frame-twists, gravel, water, salt brine and mud baths. We're talking about extreme conditions – far beyond what you would likely encounter. All so that you can be confident that Super Duty is engineered to handle your toughest jobs. And more.



NO RED RUST. THAT'S OUTSIDE-THE-BOX THINKING. And just one amazing benefit of the first-and-only body and cargo box in its class made from high-strength, military-grade, aluminum alloys. It's also more ding-resistant than the previous-generation Super Duty. And by saving up to 350 lbs. of weight, it allowed us to upgrade essential components – frame, axles, leaf springs, transfer case, driveline and trailer hitches.

UP TO 24 TIMES STIFFER THAN THE PREVIOUS GENERATION. Thanks to a fully boxed ladder frame made with high-strength steel and through-welded, closed-section crossmembers. The result? The best ride and steering of any Super Duty ever.

EXTREME DURABILITY AND CORROSION PROTECTION results from an e-coat paint process that electrostatically bonds a protective barrier to the frame.

THE LARGEST BRAKE ROTORS in the class belong to F-450. When you're hauling tons of equipment, you need sure stopping power.

STANDARD: F-450 - ALL TRIMS





AXLES ARE STRONG and capable. Ratios range from 3.31 to 4.30. Choices include non-limited-slip, limited-slip and electronic-locking¹ Gear and bearing designs are engineered and optimized by weight for the extreme capability of the 2019 Super Duty.

DRIVESHAFTS, TRANSFER CASES AND U-JOINTS are engineered to handle the monstrous torque output of both Super Duty engines. In the 4WD transfer case, an electro-magnetic clutch provides smooth and immediate shift-on-the-fly capability in conditions where additional traction is needed.

LARGE 2.5" AND X-LARGE 3" TRAILER HITCHES are built right into the frame, extending so far underneath (and using so much high-strength steel) that weight-equalizing bars aren't needed - saving time and effort when hooking up a trailer. On many configurations, hitches are weight-carrying² up to the max. tow ratings.

Until the job site is poured and screeded, you rely on Super Duty to get your heavy equipment and tools through mud, sand, snow and difficult terrain. Thankfully, on 4x4 models with electronic shift-on-the-fly, engaging 4WD is as simple as setting the proven manual-locking front hubs to AUTO and turning a dial on the instrument panel. In the 2019 Ford Super Duty, you're well-prepared to conquer the toughest terrain.

FX4 OFF-ROAD PACKAGE. Increase your off-road capability by adding transfer case and fuel tank skid plates, Hill Descent Control,[™] and off-road-tuned shocks that help get you ready for serious, low-speed crawling. An electronic-locking rear differential¹ (SRW models) uses a true mechanical dog-clutch mechanism to lock the rear axle shafts together so they turn at the same speed for maximum gripping power.

AVAILABLE: ALL TRIMS



SUPER DUTY CAPABILITY

There's capability. And then there's Super Duty capability. Our owners expect the best. The 2019 Ford Super Duty delivers. On multiple levels. Need to tow more than 17 tons? You'll be driving a Super Duty. If your conventional towing needs approach 21,000 lbs., that's Super Duty as well. Want to haul more than anyone else? Then load up the cargo box of a Super Duty. Get the picture? No matter what limit you need to test, you'll find your answer in an F-250, F-350 or F-450 Ford Super Duty.



	F-250	F-350	F-450		
MAX. TOWING ¹	18,500 LBS.	32,000 LBS.	CLASS-BEST 35,000 LBS.	CLASS - BEST 43,300 LBS. MAXIMUM GCWR <small>F-450</small>	CLASS - BEST 21,000 LBS. CONVENTIONAL TOWING <small>F-350/F-450</small>
MAX. CONVENTIONAL TOWING ¹	18,000 LBS.	CLASS-BEST 21,000 LBS.	CLASS-BEST 21,000 LBS.		
MAX. PAYLOAD ¹	4,270 LBS.	CLASS-BEST 7,640 LBS.	6,190 LBS.	CLASS - BEST 35,000 LBS. MAXIMUM TOWING <small>F-450 REGULAR CAB 4x2</small>	CLASS - BEST 7,640 LBS. MAXIMUM PAYLOAD <small>F-350 DRW REGULAR CAB 4x2</small>
MAX. GVWR ¹	10,000 LBS.	14,000 LBS.	14,000 LBS.		
MAX. GCWR ¹	25,700 LBS.	40,000 LBS.	CLASS-BEST 43,300 LBS.		
ENGINES	6.2L GAS V8 6.7L POWER STROKE® V8 TURBO DIESEL	6.2L GAS V8 6.7L POWER STROKE V8 TURBO DIESEL	6.7L POWER STROKE V8 TURBO DIESEL		
DRIVETRAINS	SINGLE REAR WHEEL (SRW) 4x2 OR 4x4	SRW OR DUAL REAR WHEEL 4x2 OR 4x4	DUAL REAR WHEEL 4x2 OR 4x4		
CAB TYPES	REGULAR CAB, SUPERCAB, CREW CAB	REGULAR CAB, SUPERCAB, CREW CAB	REGULAR CAB, CREW CAB		
BOX LENGTHS	6.75' OR 8'	6.75' OR 8'	8'		
AVAILABILITY	ALL TRIMS	ALL TRIMS	ALL TRIMS		

2019 Super Duty® | ford.com

F-250 XLT Crew Cab 4x4. Magnetic. F-350 LARIAT SuperCab 4x4. Magnetic. F-450 PLATINUM Crew Cab. White Platinum. All shown with available equipment.

¹When properly configured. See Payload and Towing charts in the Specifications section for maximum ratings by configuration.



SUPER DUTY MUSCLE

Among heavy-duty trucks, torque is king. And Super Duty boasts more than anyone else in the kingdom. Its B20-capable 6.7L Power Stroke® V8 Turbo Diesel¹ and 6.2L V8 gas engines both lead their categories in torque delivery. A rugged TorqShift® 6-speed SelectShift® automatic transmission that's just as hard working is paired with them. Its progressive range select mode lets you narrow the available gear range in difficult road/load conditions, while tow/haul mode reduces frequent gear shifting on uphill grades and allows engine braking to help maintain vehicle speed while descending.

Plus, a live-drive power takeoff (PTO) provision¹ for accessory operation delivers power anytime, providing stationary and mobile-mode PTO capability. Both engines and the transmission are designed, engineered and built by Ford, so each Built Ford Tough® powertrain works seamlessly with chassis components and vehicle calibrations.



6.7L POWER STROKE® V8 TURBO DIESEL

Its class-leading torque output speaks volumes to the workers who rely on it daily. "That is closing in on 18-wheeler levels of twist," says *AutoWeek*. Twin-pilot injection delivers smooth, quiet acceleration. Excellent throttle response is delivered in part by a high-pressure, common rail fuel injection system. The fuel pump develops up to 29,000 psi operating pressure, and piezo-controlled fuel injectors provide precise injection. Robust high-altitude performance comes courtesy of the high airflow supplied by the diesel's variable-geometry turbocharger. Tuned specifically for this application, the turbocharger forces air into the cylinders to deliver maximum power quickly. A driver-controlled engine exhaust brake with on, off and auto settings allow the use of engine braking to help slow down and control vehicle speed. Large fuel tanks – up to 48 gallons maximum¹ – help extend range.

- F-250/F-350: LIMITED F-450: ALL TRIMS
- F-250/F-350: XL, XLT, LARIAT, KING RANCH® PLATINUM

Strength and integrity of the diesel is maintained by a masterful mix of component materials. Compacted graphite iron (CGI) imparts strength and durability to the deep-skirt engine block, while reducing weight. Cylinder heads made of aluminum help to further reduce weight and feature a 6-head-bolt-per-cylinder design to help improve sealing and maintain cylinder integrity.

CLASS-BEST
935 LB.-FT. TORQUE

CLASS-BEST
450 HORSE POWER



6.2L 2-VALVE GAS V8 FFV

A stiff SOHC valvetrain with roller-rocker shafts enables an intake- and exhaust-port layout that optimizes airflow, helping the E85-capable 6.2L V8 engine produce plenty of torque down low. Dual-equal variable cam timing phases the intake- and exhaust-valve opening and closing events simultaneously to optimize low-end torque and peak horsepower. By supplying working power throughout the rpm range, the 6.2L V8 delivers an exceptional combination of driveability, hauling and towing performance.

- F-250/F-350: XL, XLT, LARIAT, KING RANCH, PLATINUM

COMPRESSED NATURAL GAS (CNG)/PROPANE CAPABILITY. A CNG/Propane Gaseous Engine Prep Package readies Super Duty gas models to be upfit for compressed natural gas (CNG) or propane autogas. Providing flexibility and extended range, trucks upfit to a bi-fuel system have the ability to switch between CNG or propane and gasoline and include tanks for each type of fuel. By doing so, you may even qualify for state incentives related to alternative fuel use. Visit www.afdc.energy.gov/afdc/laws for details.

- XL, XLT, LARIAT, KING RANCH, PLATINUM

Iron-clad durability of the gas engine block stems from reliable cast-iron construction, with 4-bolt main bearing caps, including 2 additional cross bolts. Piston-cooling jets contribute to durability as well by maintaining cooler piston temperatures and improving oil warm-up, especially under heavy-duty operating conditions.

CLASS-BEST GAS
430 LB.-FT. TORQUE

385 HORSE POWER

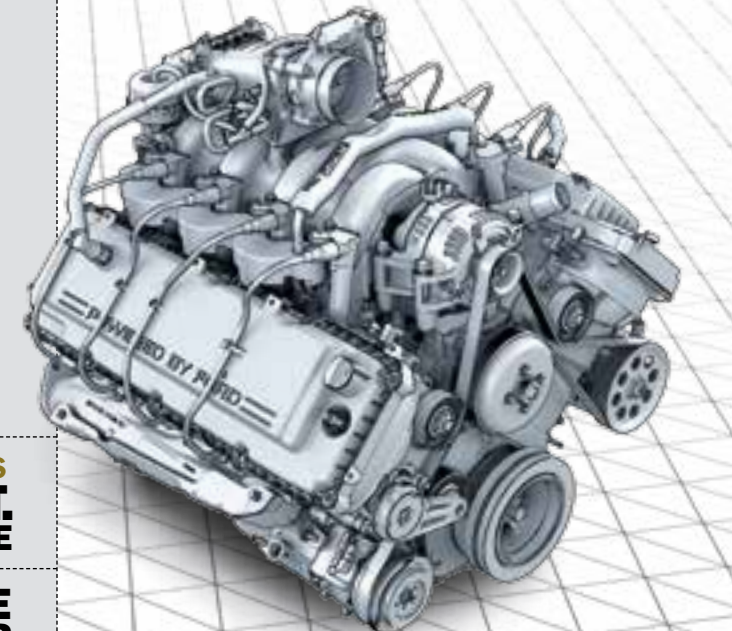

● STANDARD ○ AVAILABLE

2019 Super Duty® | ford.com

¹Available feature.



SUPER DUTY BRINGS CONFIDENCE IN TOW.

Your 2019 F-Series Super Duty can be equipped with an array of convenient driver-assist features¹ that help you tow more than you ever thought possible. Adaptive cruise control^{1,2} makes handling all that weight seem almost effortless, while adaptive steering^{1,2} makes parking easier at your destination.

To help you keep truck and trailer in line, avoid a collision, and even stay in your lane, sophisticated radar¹ and up to 7 strategically placed cameras¹ are at your service – inspiring confidence on every journey.



CLASS-EXCLUSIVE ADAPTIVE CRUISE CONTROL helps maintain your choice of speed and preset gaps from the vehicle in front of you. It can also alert you to a potential collision. If one is detected, adaptive cruise control & forward collision warning with brake support^{1,2} flashes a warning on the windshield, sounds an alarm, and can pre-charge the brake system to provide full responsiveness when you do brake.

● LIMITED ○ LARIAT, KING RANCH, PLATINUM

CLASS-EXCLUSIVE ADAPTIVE STEERING^{1,2} adapts to different driving conditions and reduces the amount of steering input needed, depending on speed and load. Whether backing up, trailering or maneuvering through a parking lot, this helps make Super Duty more manageable to drive, especially with a load in tow.

● PLATINUM, LIMITED ○ LARIAT, KING RANCH

CLASS-EXCLUSIVE INDIVIDUAL TRAILER TIRE PRESSURE MONITORING SYSTEM¹ can monitor and display the individual tire pressures of a connected trailer. This class-exclusive system can alert you if any tire's pressure is low on the 8" color LCD productivity screen.¹ A numerical value will even tell you how low.

○ XLT, LARIAT, KING RANCH, PLATINUM, LIMITED

LANE-KEEPING ALERT^{1,2,3} can detect lane markings and send vibration pulses to the steering wheel if it senses Super Duty drifting unintentionally out of its lane.

● LIMITED ○ LARIAT, KING RANCH, PLATINUM

ADVANCETRAC[®] WITH RSC[®] (ROLL STABILITY CONTROL[™])⁴ utilizes gyroscopic sensors to help keep all wheels firmly planted. By selectively applying brakes and modifying engine power, it enhances vehicle stability in a wide range of driving conditions.

● ALL TRIMS

TRAILER SWAY CONTROL⁴ monitors the motions of the truck to detect trailer sway and selectively applies the brakes as needed, helping you maintain control of the truck and the trailer.

● ALL TRIMS

CLASS-EXCLUSIVE BLIS[®] (BLIND SPOT INFORMATION SYSTEM) WITH TRAILER COVERAGE^{1,2} alerts you with a light in either sideview mirror if its radar sensors detect a vehicle in the corresponding blind spot. The system is optimized for Super Duty to extend the range of BLIS to include a conventional trailer, once programmed into the productivity screen.

● PLATINUM, LIMITED ○ XL, XLT, LARIAT, KING RANCH

● STANDARD ○ AVAILABLE

2019 Super Duty[®] | ford.com

¹Available feature. ²Driver-assist features are supplemental and do not replace the driver's attention, judgment and need to control the vehicle. ³Lane-keeping alert does not control steering.

⁴Remember that even advanced technology cannot overcome the laws of physics. It's always possible to lose control of a vehicle due to inappropriate driver input for the conditions.



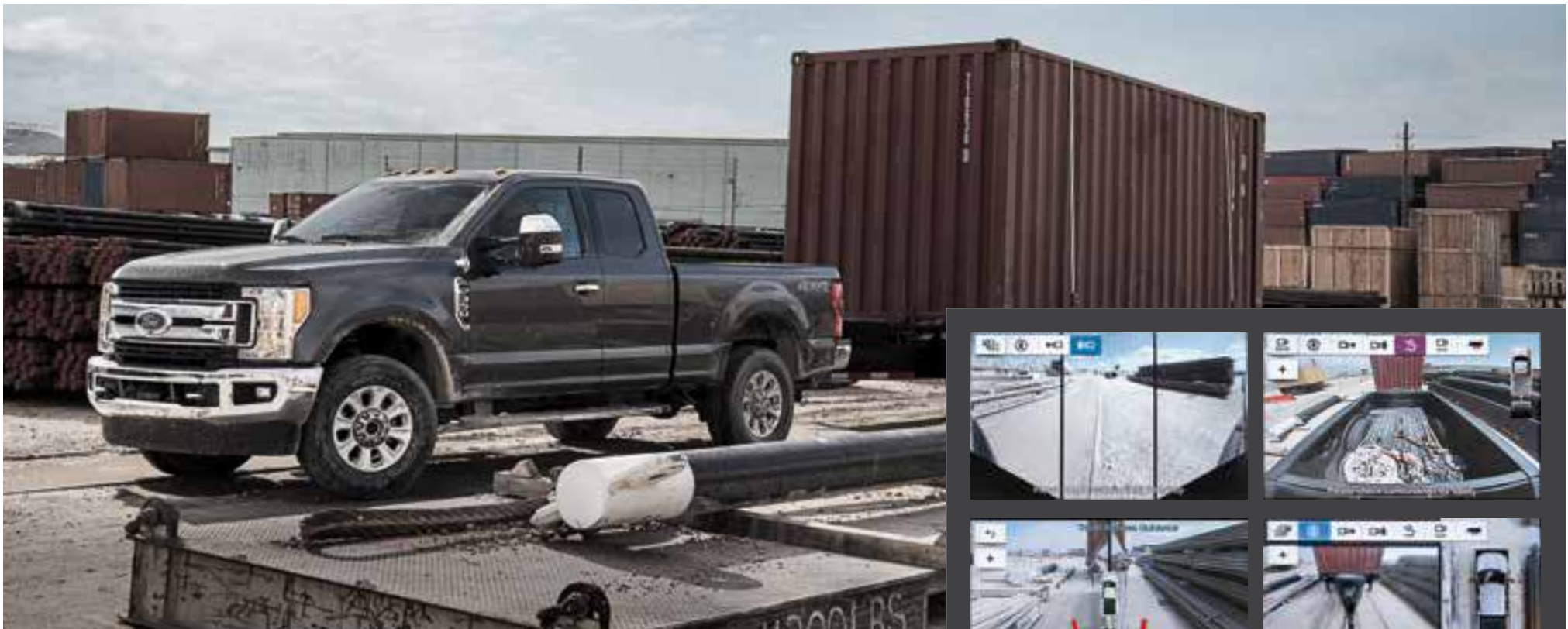

WORKING HARD TO EXPAND YOUR VISION.

When there's valuable equipment in tow, what you can see from the driver's seat can help make all the difference. Strategically placed cameras^{1,2} not only aid in hooking up your trailer to Super Duty, but in maneuvering it as well. On all models, a rear view camera is standard. Then, from XL all the way to LIMITED, upgrade to the Ultimate Trailer Tow Camera System.^{1,2} It adds high-definition 180-degree front and side cameras for a 360-degree view around the truck, a center high-mounted stop lamp (CHMSL) camera, as well as Trailer Reverse Guidance. You can even attach a weatherproof, customer-placed trailer camera^{1,2} to the rear of your trailer to see behind it. In all, up to 7 cameras^{1,2} help make the 2019 F-Series Super Duty the ultimate towing machine.

REAR VIEW CAMERA

● ALL TRIMS

REAR CHMSL CAMERA

● LIMITED ○ XL, XLT, LARIAT, KING RANCH® PLATINUM

CUSTOMER-PLACED TRAILER CAMERA

○ XLT, LARIAT, KING RANCH, PLATINUM, LIMITED

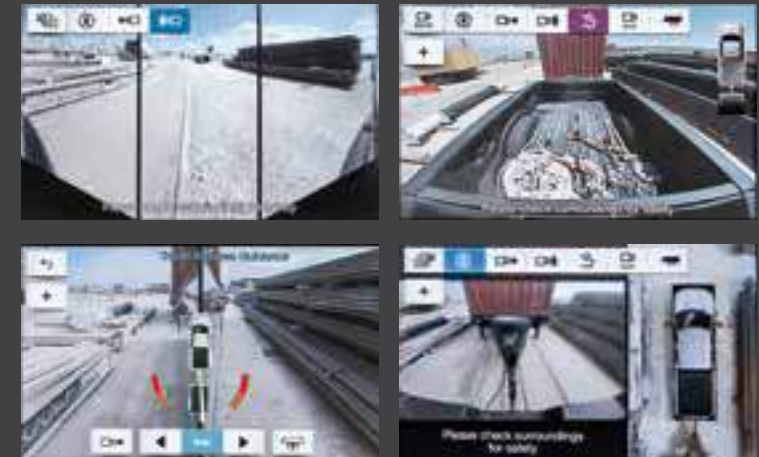

Clockwise from upper left:

FRONT SPLIT VIEW supplies a 180-degree view in front of Super Duty. This allows you to see to the left and right before you have a line of sight, displaying a view around corners and out of parking spots as you slowly drive forward.

REAR CHMSL CAMERA VIEW WITH ZOOM FUNCTION is particularly helpful when connecting your 5th-wheel/gooseneck trailer.

REAR + 360 VIEW provides a rear view, plus the 360-degree view generated by the front, rear and sideview mirror cameras.

TRAILER REVERSE GUIDANCE³ automatically switches between side and rear camera views to show you what's most relevant while backing up your trailer, and provides overlays to guide you.

ULTIMATE TRAILER TOW CAMERA SYSTEM

● LIMITED ○ XL, XLT, LARIAT, KING RANCH, PLATINUM

● STANDARD ○ AVAILABLE

2019 Super Duty® | ford.com

F-350 XLT SuperCab 4x4. Magnetic. XLT Premium Package. Available equipment. ¹Available feature. ²Driver-assist features are supplemental and do not replace the driver's attention, judgment and need to control the vehicle. ³Some of the Trailer Reverse Guidance automated features do not work with gooseneck or 5th-wheel trailers, but you can still manually control the camera views on the touchscreen to help you back up these types of trailers. Setup and sticker placement are not required.



Day or night, F-Series Super Duty is the tool you need to finish any job. Its heavily fortified cargo box comes in 6.75' and 8' lengths. Around and inside that easy-to-access box is an amazing array of available class-exclusive technology. All engineered for one purpose: helping you become as proficient and productive as possible 24/7.



CLASS-EXCLUSIVE LED SIDEVIEW MIRROR SPOTLIGHTS

● LARIAT, KING RANCH® PLATINUM, LIMITED ○ XLT

● STANDARD ○ AVAILABLE



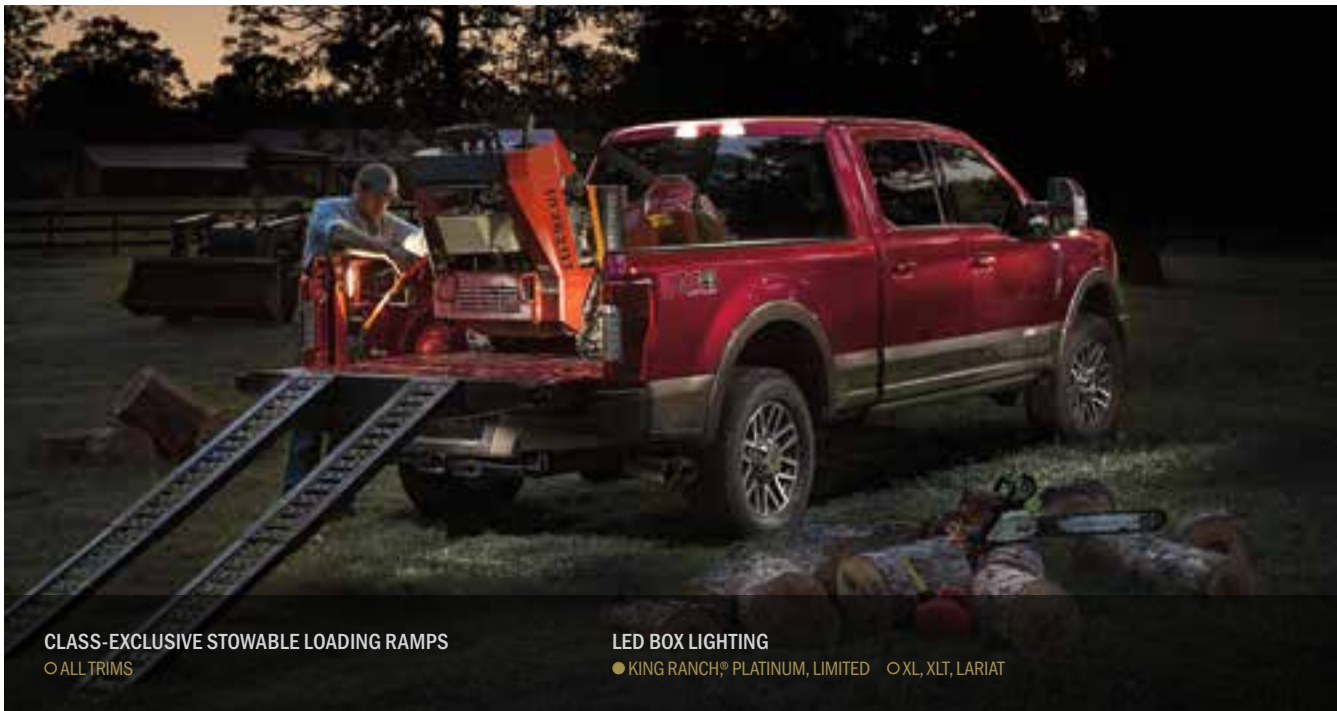

CLASS-EXCLUSIVE STOWABLE LOADING RAMPS
 ○ ALL TRIMS

LED BOX LIGHTING
 ● KING RANCH, PLATINUM, LIMITED ○ XL, XLT, LARIAT



CLASS-EXCLUSIVE POWERSCOPE® POWER-TELESCOPING/-FOLDING TRAILER TOW MIRRORS
 ● LARIAT, KING RANCH, PLATINUM, LIMITED ○ XLT



CLASS-EXCLUSIVE REMOTE TAILGATE RELEASE
 ● KING RANCH, PLATINUM, LIMITED ○ LARIAT



EXTENDED-LENGTH STEP BARS
 ○ XLT, LARIAT, KING RANCH

CLASS-EXCLUSIVE TAILGATE STEP
 ● PLATINUM, LIMITED ○ XL, XLT, LARIAT, KING RANCH



CLASS-EXCLUSIVE BOXLINK™ WITH LOCKING CLEATS
 ● XLT, LARIAT, KING RANCH, PLATINUM, LIMITED ○ XL

● STANDARD ○ AVAILABLE





A PERFECT MIX OF HEAVY-DUTY BUSINESS AND HIGH-PERFORMANCE PLEASURE.

“The Super Duty pickup is the pinnacle of the heavy-duty class until further notice,” says *Car and Driver*.¹ “Its serene cabin can be outfitted for a king or stripped down for a contractor.” Loads of storage swallows tools and supplies, and easy-to-navigate controls help you stay highly productive. Start with the 8" color LCD productivity screen,² which lets you choose up to 7 of your favorite screens and arrange them for your convenience.

New this year, a B&O PLAY™ Premium Audio System by HARMAN.² A 10-channel amplifier pumps 1,000 watts of digitally processed sound through 10 high-performance speakers, including 4 midwoofer speakers and a subwoofer. It joins a long list of amenities that make any haul in Super Duty more comfortable than you can imagine.

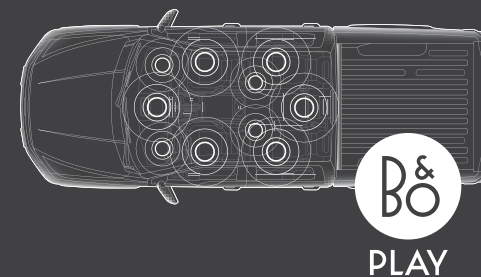

HEATED, LEATHER-WRAPPED STEERING WHEEL

● KING RANCH[®] PLATINUM, LIMITED ○ LARIAT

POWER-TILT/-TELESCOPING STEERING COLUMN WITH MEMORY

● KING RANCH, PLATINUM, LIMITED ○ LARIAT

6 OVERHEAD UPFITTER SWITCHES

● LIMITED ○ XL, XLT, LARIAT, KING RANCH, PLATINUM

110V/400W AC POWER OUTLET IN IP

● LARIAT, KING RANCH, PLATINUM, LIMITED ○ XL, XLT

● STANDARD ○ AVAILABLE

2019 Super Duty® | ford.com

PLATINUM Crew Cab 4x4. Dark Marsala leather-trimmed interior. Available equipment. ¹*Car and Driver*, 02/17. ²Available feature.





PRODUCTIVITY HAS ITS PERKS.

Smart storage is everywhere in Super Duty. Even under the rear seat. Collapsible under-seat storage can be raised, divided and locked when the seat is folded down, then fold into the floor when not in use for a convenient flat load floor. Two glove boxes include a unique upper compartment for additional storage space. While the front center console¹ is large enough to hang file folders.

On LIMITED, step up to class-exclusive multicontour front seats that feature Active Motion[®] massage and LIMITED badging. Camelback two-tone premium luxury leather trims the front seats, steering wheel and center console lid. A Miko[®] headliner and twin-panel moonroof cover the cab, while a VIN plate on the center console lid reminds you of how unique your truck really is.



TWIN-PANEL MOONROOF
(Crew Cab only)

● LIMITED ○ XLT, LARIAT, KING RANCH, PLATINUM

CLASS-EXCLUSIVE COLLAPSIBLE REAR UNDER-SEAT STORAGE (Crew Cab only)

● XLT, LARIAT, KING RANCH[®] PLATINUM, LIMITED

FIRST-IN-CLASS INFLATABLE REAR SAFETY BELTS (Crew Cab only)

○ ALL TRIMS

HEATED REAR OUTBOARD SEATS
(Crew Cab only)

● PLATINUM, LIMITED ○ LARIAT, KING RANCH

HEATED AND COOLED, 10-WAY POWER-ADJUSTABLE FRONT BUCKET SEATS

● KING RANCH, PLATINUM, LIMITED ○ LARIAT

● STANDARD ○ AVAILABLE

2019 Super Duty[®] | ford.com

LIMITED Crew Cab 4x4. Camelback two-tone leather-trimmed seats. Available equipment. ¹Available feature.





STAY CONNECTED ON THE MOVE



IT ALL STARTS HERE

This vibrant 8" touchscreen is the command center of SYNC® 3 voice-activated technology,^{1,2} which integrates your paired mobile phone with Ford Super Duty as soon as you start your truck. Make calls. Send and receive text messages. And so much more. Just swipe left or right, or use simple voice commands, to help ensure that your life doesn't miss a beat. SYNC 3 also features 2 smart-charging USB ports to help keep your devices powered up.

LINK YOUR APPS

SYNC 3 AppLink^{®3} links your favorite compatible mobile apps with your voice, giving you convenient control. iPhone[®] users can view the Waze[™] app's community-based navigation and traffic features on the large SYNC 3 touchscreen. Amazon Alexa users can access thousands of skills and services they enjoy on their Amazon Echo with the Ford+Alexa⁴ app.

CONNECT TO FORDPASS CONVENIENCE

New FordPass[™] Connect's 4G LTE Wi-Fi hotspot^{2,5} lets passengers connect tablets, laptops and smartphones. It includes a complimentary 3-month or 3GB data trial. And that's only part of its convenience. Together with the FordPass smartphone app,⁶ FordPass Connect allows you to remotely start² your truck and climate control system using your smartphone. As well as locate your vehicle and check approximate fuel range. FordPass also helps you find fuel and compare prices. Find, reserve and pre-pay for parking in select locations. Plus, get help 24/7 from our trained team of Ford Guides.

CONNECT YOUR iPhone

Apple CarPlay[™] compatibility^{2,7} displays the iPhone interface on your vehicle's touchscreen. Send and receive text messages by voice. Get directions. Access playlists from Apple Music.[®] Just ask Siri[®] for help. She already knows your voice.

CONNECT YOUR ANDROID PHONE

Android Auto[™] compatibility^{2,7} displays the Android[™] interface on your vehicle's touchscreen. Get voice-guided navigation from Google Maps[™] and Waze. Access your favorite music from your apps. Make calls. Send and receive messages. Just talk to Google[™] Assistant and go.

MAP YOUR ROUTE

Voice-activated navigation² delivers turn-by-turn directions and vivid 3-D maps on the SYNC 3 touchscreen. Pinch-to-zoom capability allows for a closer look. SiriusXM[®] Traffic & Travel Link^{®8} helps you avoid traffic – before you're in the middle of it. It also provides fuel prices and station locations. Current and forecasted weather. Movie locations and showtimes. Plus, the scores of your favorite sports teams, and more.



GET DIRTY...



XL

Featuring black grille and bumpers, plus heavy-duty vinyl seating, this no-nonsense work truck is the bedrock of the Super Duty lineup. It has all the capability and standard features to get you comfortably through the work week. Plus, if your needs require, it can be equipped to move huge payloads and tow king-size trailers. Add additional style and functionality with the STX Appearance Package or FX4 Off-Road Package.

F-250 Regular Cab 4x2. Oxford White.
Available equipment shown.



XLT

Takes all the great features of the XL work truck and adds just the right level of refinement with its substantial list of popular standard features. Like a chrome grille and bumpers. Cloth seating and carpeted flooring. Power windows and locks. Class-exclusive BoxLink™ with premium locking cleats. SiriusXM®. Its wide range of cabs, boxes and content options makes it an incredibly versatile truck that's a great addition to any lineup.

F-250 SuperCab 4x2. Ruby Red. XLT Premium Package.
Available equipment shown.



LARIAT

LARIAT standards put you at ease behind the wheel, so you're always ready to tackle the day. Leather-trimmed, 10-way power-adjustable front bucket seats and power-adjustable pedals help drivers of all sizes feel at home. An 8" LCD productivity screen puts vital vehicle information front and center. Control the remarkable SYNC® 3, as well as a new B&O PLAY™ Premium Audio System by HARMAN. Keep a watchful eye out back with PowerScope® power-telescoping/-folding trailer tow mirrors.

F-250 Crew Cab 4x4. Blue Jeans. Chrome Package.
Available equipment shown.

WITH OUR MOST DIVERSE LINEUP EVER



KING RANCH

Conveys Southwestern luxury at its finest, starting with the standard two-tone exterior trim. Inside, Kingsville leather trim covers the heated and cooled 10-way power front seats, flow-through console lid and heated steering wheel of the KING RANCH® Crew Cab. Seat backs, floor mats, center console lid and wheels are branded with the legendary "Running W" logo of the historic King Ranch in Kingsville, Texas. Voice-activated Navigation with SiriusXM® Traffic and Travel Link® helps guide you on your way.

F-350 Crew Cab 4x4. White Platinum/Stone Gray. Chrome Package. Available equipment shown.



PLATINUM

A cut above, with standard LED lighting front and rear (headlamps, fog lamps and taillamps), as well as polished aluminum wheels, plus satin-aluminum and chrome exterior accents. Inside, multicontour premium leather-trimmed front seats with Active Motion® are trimmed in Dark Marsala or Black. Adaptive steering and BLIS® with trailer-tow coverage improve on your already powerful capability. The 2019 Super Duty PLATINUM.

F-450 Crew Cab 4x4. Agate Black. Available equipment shown.



LIMITED

This is the most luxurious, technologically advanced Super Duty ever. LIMITED comes ready to work with the 6.7L Power Stroke® V8 Turbo Diesel, electronic shift-on-the-fly 4WD, and the Ultimate Trailer Tow Camera System all standard. As well as a truckload of amenities that includes polished aluminum wheels and class-exclusive power-deployable running boards. When you expect nothing but the best, step up to LIMITED.

F-450 Crew Cab 4x4. White Platinum.

STANDARD FEATURES

MECHANICAL

Narrow-track front axle (F-250/F-350)
Wide-track front axle (F-450)
Twin-I-Beam coil spring front suspension with stabilizer bar (4x2)
Twin-coil monobeam front suspension with stabilizer bar (4x4 and F-450 4x2)
Leaf-spring rear suspension
Rear stabilizer bar (DRW)
Heavy-duty gas shock absorbers
Hydraulic power-assisted steering
Power 4-wheel disc brakes with Anti-Lock Brake System (ABS)
Electronic shift-on-the-fly transfer case with manual locking hubs (4x4)
Jack (2-ton mechanical with SRW; 4-ton hydraulic with DRW)
Intelligent Oil-Life Monitor® (diesel engine)
Oil-life minder (gas engine)
Stationary Elevated Idle Control (SEIC)¹

Trailer sway control

2.5" trailer hitch receiver (F-250; F-350 SRW)
3.0" trailer hitch receiver with 2.5"-3.0" sleeve reducer (F-350 SRW Crew Cab 176" WB with diesel engine; DRW)
7-wire trailer tow wiring harness with relays and 7-/4-pin connector

DRIVER-ASSIST TECHNOLOGY

Autolamp automatic on/off headlamps with rainlamp feature
Hill start assist

INTERIOR

12V powerpoints, 2 in instrument panel
Lockable glove boxes (2)
Outside temperature display
Driver and front-passenger grab handles, and rear-passenger on Crew Cab
Dome light and dual map lights
Overhead console with dual storage bins (SuperCab/Crew Cab)

EXTERIOR

Variable-intermittent windshield wipers with washers
Configurable daytime running lamps
Front tow hooks (2)
Underhood service lamp
LED roof marker/clearance lamps (DRW)
Center high-mounted stop lamp (CHMSL) with cargo lamp
Pickup box rail and tailgate moldings
Pickup box tie-down hooks (4)
Removable tailgate with key lock

SAFETY & SECURITY

Driver and right-front-passenger front airbags²
Front-seat side airbags²
Front-passenger airbag deactivation switch (Regular Cab and SuperCab)
Safety Canopy® System with side-curtain airbags² and rollover sensor
AdvanceTrac® with RSC® (Roll Stability Control™)
Belt-Minder® front safety belt reminder
Child-safety-seat top tether anchors (Regular Cab front passenger, and all rear-seat positions)
Front height-adjustable shoulder safety belts
Individual Tire Pressure Monitoring System (F-250/F-350, excludes spare)
MyKey® technology to help encourage responsible driving
Rear view camera with dynamic hitch assist
SecuriLock® Passive Anti-Theft System
SOS Post-Crash Alert System™



XL

4x2 | STANDARD

4x4 | AVAILABLE

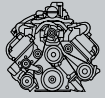

**6.2L 2-VALVE GAS
V8 FFV**

STANDARD: F-250, F-350

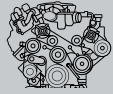

**6.7L POWER STROKE®
V8 TURBO DIESEL**

STANDARD: F-450
AVAILABLE: F-250, F-350

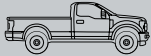

REGULAR CAB | 8' BOX

F-250 SRW, F-350 SRW,
F-350 DRW, F-450 DRW

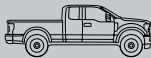

SUPERCAB | 6.75' BOX

F-250 SRW, F-350 SRW

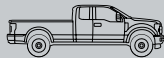

SUPERCAB | 8' BOX

F-250 SRW, F-350 SRW,
F-350 DRW

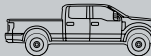

CREW CAB | 6.75' BOX

F-250 SRW, F-350 SRW

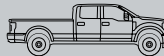

CREW CAB | 8' BOX

F-250 SRW, F-350 SRW,
F-350 DRW, F-450 DRW



**40/20/40
SPLIT FRONT SEAT**
STANDARD



**40/MINI-CONSOLE/40
FRONT BUCKET SEATS**
AVAILABLE



XL

INCLUDES STANDARD FEATURES, PLUS:

MECHANICAL

650-CCA, 72-amp-hr single battery (gas)
750-CCA, 78-amp-hr dual batteries (diesel)
Spare wheel, tire, lock, frame-mounted carrier and jack (optional with pickup box delete)
Trailer brake controller with Smart Trailer Tow Connector (DRW)

SEATING

Heavy-duty vinyl-trimmed seating
40/20/40 split front seat with 2-way manual seat adjust, driver's side manual lumbar, and folding armrest with cupholders and storage
60/40 split flip-up rear seat (SuperCab/Crew Cab)

INTERIOR

AM/FM stereo
2.3" productivity screen in instrument cluster
Black vinyl flooring
Fixed rear window
Manual-tilt/-telescoping steering column
Single-zone manual climate control

EXTERIOR

Black door and tailgate handles
Black grille
Black-painted steel bumpers
Black tow hooks
Manually telescoping trailer tow mirrors with 2-way fold, manual glass and black mirror caps
Quad-beam jewel-effect halogen headlamps

AVAILABLE FEATURES AND PACKAGES:

MECHANICAL

750-CCA, 78-amp-hr dual batteries (gas)
Engine block heater
Engine idle shutdown (5-, 10-, 15- or 20-minute)
Manual transfer case (4x4; deletes standard electronic shift-on-the-fly transfer case)
Operator-commanded exhaust filter regeneration (diesel engine)
Power takeoff (PTO) provision with transmission-mounted live-drive and stationary modes¹ (PTO port located on driver's side; split-shaft capability included with diesel engine only; n/a on F-250 with gas engine)
Trailer brake controller with Smart Trailer Tow Connector (SRW)
Trailer tow – 5th-wheel hitch^{1,2} (18,000-lb. rating on SRW, 27,500-lb. rating on DRW)
Trailer tow – Gooseneck dual hitch kit includes one 2 5/16" gooseneck ball, one 3" gooseneck ball, and 2 safety chain tie-down bars^{1,2} (F-450)
Trailer tow – Gooseneck hitch kit^{1,2} (F-250/F-350)
Upfitter interface module (Fleet only)

SEATING

Cloth-trimmed seating
Front bucket seats with mini-console and driver's side manual lumbar

INTERIOR

SiriusXM^{®1} with 6-month trial subscription³
110V/400W AC power outlet in instrument panel¹
Flooring – Carpet with carpeted floor mats¹
Inflatable rear safety belts in outboard seating positions¹ (Crew Cab)
Power-sliding rear window with privacy glass and defroster¹ (SuperCab/Crew Cab)
Privacy glass rear window with defroster¹
Rapid-heat supplemental cab heater¹ (diesel engine; standard where required)
Upfitter switches, 6 located in overhead console¹

EXTERIOR

Bed mat¹
Bedliner – Drop-in¹
Bedliner – Tough Bed[®] spray-in with tailgate guard
Black molded hood deflector
BoxLink™ with 4 premium locking cleats
Cab steps – 6" chrome angular step bars¹
Cab steps – Black platform running boards
Camera – Rear CHMSL camera¹
Camera – Ultimate Trailer Tow Camera System¹ (includes trailer hook-up lamp, 360-degree camera with Split-View Display, rear CHMSL camera with LED CHMSL, and Trailer Reverse Guidance)
Exterior backup alarm⁴
LED box lighting with LED CHMSL¹
LED roof marker/clearance lamps (SRW)
LED warning strobes^{1,4}
Remote Start System¹
Skid plates (4x4)
Splash guards, molded¹ (SRW)
Stowable loading ramps¹
Tailgate step with grab bar and tailgate lift assist
Toolbox – Aluminum crossbed by WEATHER GUARD^{®4}
Toolbox – Premium aluminum crossbed by WEATHER GUARD⁴
Wheel-well liners¹

TECHNOLOGY

BLIS[®] (Blind Spot Information System) with trailer coverage and cross-traffic alert¹
Fleet telematics modem^{1,5}
FordPass™ Connect^{1,6} embedded 4G LTE modem powered by FordPass app⁷ (includes Wi-Fi hotspot capability)
SYNC[®] Voice Recognition Communications and Entertainment System¹ with 4.2" color LCD screen and 1 smart-charging USB port; and AM/FM stereo with MP3 capability
SYNC 3¹ with 8" color LCD capacitive touchscreen in center stack, 911 Assist[®] AppLink[®] Apple CarPlay™ compatibility, Android Auto™ compatibility, and 2 smart-charging USB ports; and 4.2" productivity screen in instrument cluster

PACKAGES

Power Equipment Group:¹ accessory delay for power features; trailer tow mirrors with 2-way fold, power/heated glass, heated manual spotter mirrors, and integrated clearance lamps and turn signal indicators; perimeter alarm; Advanced Security Pack with inclination/intrusion sensors; power door and tailgate locks; power windows with front one-touch-up/-down feature; and Remote Keyless Entry System with 2 integrated keyhead transmitter remotes

STX Appearance Package:¹ chrome grille and bumpers, 18" cast-aluminum wheels with bright center caps and LT275/65R18E BSW all-season tires (SRW), 17" polished forged-aluminum wheels (F-350 DRW), STX fender vent badges, SYNC, AM/FM stereo with MP3 capability, and cruise control

XL Value Package:¹ chrome bumpers, bright center caps on wheels (SRW only), SYNC, AM/FM stereo with MP3 capability, and cruise control

Capability Packages: content can be found following the LIMITED pages

2019 Super Duty[®] | ford.com

¹Restrictions may apply. See your dealer for details. ²Requires 5th-Wheel/Gooseneck Trailer Tow Prep Package. ³After your trial period ends, SiriusXM audio and data services each require a subscription sold separately, or as a package, by Sirius XM Radio Inc. See SiriusXM Customer Agreement for complete terms at www.siriusxm.com. All fees and programming subject to change. Trial subscriptions not available in AK and HI. ⁴Ford Licensed Accessory. ⁵Late availability. ⁶FordPass Connect includes complimentary 1-year subscription for remote features, excluding Wi-Fi hotspot, and starts with vehicle sale date. Subscription is subject to compatible 4G network availability. Certain restrictions, 3rd-party terms, or message and data rates may apply. Evolving technology/cellular networks may affect future functionality. Wi-Fi hotspot includes complimentary wireless data trial that begins upon AT&T activation and expires at the end of 3 months or when 3GB of data is used, whichever comes first, but cannot extend beyond the complimentary subscription period for remote features. To activate, go to www.att.com/ford. ⁷FordPass smartphone app, for use with FordPass Connect, is available via download and compatible with select smartphone platforms. FordPass is on the App Store[®] and Google Play.[™] Learn more at fordpass.com. Message and data rates may apply.



XLT

4x2 | STANDARD

4x4 | AVAILABLE

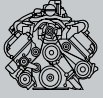

6.2L 2-VALVE GAS
V8 FFV

STANDARD: F-250, F-350

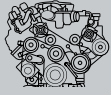

6.7L POWER STROKE®
V8 TURBO DIESEL

STANDARD: F-450
AVAILABLE: F-250, F-350

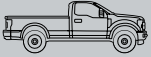

REGULAR CAB | 8' BOX

F-250 SRW, F-350 SRW,
F-350 DRW, F-450 DRW

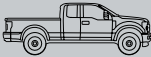

SUPERCAB | 6.75' BOX

F-250 SRW, F-350 SRW

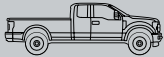

SUPERCAB | 8' BOX

F-250 SRW, F-350 SRW,
F-350 DRW

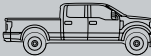

CREW CAB | 6.75' BOX

F-250 SRW, F-350 SRW

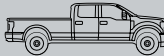

CREW CAB | 8' BOX

F-250 SRW, F-350 SRW,
F-350 DRW, F-450 DRW



40/20/40
SPLIT FRONT SEAT
STANDARD



40/CONSOLE/40
FRONT BUCKET SEATS
AVAILABLE



INCLUDES SELECT XL FEATURES, PLUS:

MECHANICAL

750-CCA, 78-amp-hr single battery (gas)
Trailer brake controller with Smart Trailer Tow Connector

SEATING

Cloth-trimmed seating
40/20/40 split front seat, center under-seat lockable storage with 12V powerpoint, and folding armrest with cupholders and storage
Rear under-seat fold-flat storage, lockable and partitionable (Crew Cab)
Rear under-seat storage (SuperCab)

INTERIOR

AM/FM stereo with MP3 capability
SiriusXM® with 6-month trial subscription¹
4.2" LCD productivity screen in instrument cluster
Carpet with carpeted floor mats
Cruise control
Power door and tailgate locks
Power windows

EXTERIOR

Advanced Security Pack with inclination/intrusion sensors
Black platform running boards (DRW)
BoxLink™ with 4 premium locking cleats
Chrome bumpers
Chrome grille
Manually telescoping trailer tow mirrors with 2-way fold, power/heated glass, heated manual spotter mirrors, and integrated clearance lamps and turn signal indicators
Privacy glass on rear doors and rear window
Remote Keyless Entry System

TECHNOLOGY

SYNC® Voice Recognition Communications and Entertainment System with 4.2" color LCD screen and 1 smart-charging USB port

AVAILABLE FEATURES AND PACKAGES:

MECHANICAL

750-CCA, 78-amp-hr dual batteries (gas)
Engine block heater
Engine idle shutdown (5-, 10-, 15- or 20-minute)
Manual transfer case (4x4; deletes standard electronic shift-on-the-fly transfer case)
Operator-commanded exhaust filter regeneration (diesel engine)
Power takeoff (PTO) provision with transmission-mounted live-drive and stationary modes² (PTO port located on driver's side; split-shaft capability included with diesel engine only; n/a on F-250 with gas engine)
Trailer tow – 5th-wheel hitch^{2,3} (18,000-lb. rating on SRW, 27,500-lb. rating on DRW)
Trailer tow – Gooseneck dual hitch kit^{2,3} includes one 2 5/16" gooseneck ball, one 3" gooseneck ball, and 2 safety chain tie-down bars (F-450)
Trailer tow – Gooseneck hitch kit^{2,3} (F-250/F-350)
Upfitter interface module (Fleet only)

SEATING

Front bucket seats with flow-through center console with lockable storage and 2 rear-facing powerpoints² (SuperCab/Crew Cab)

INTERIOR

Voice-activated Navigation System² with integrated SiriusXM Traffic and Travel Link® with 5-year subscription¹
110V/400W AC power outlet on instrument panel² (also on the back of the flow-through center console, if equipped)
Flooring – Black vinyl/carpet delete
Flooring – Floor liners²
Inflatable rear safety belts in outboard seating positions² (Crew Cab)
Power-sliding rear window with privacy glass and defroster (SuperCab/Crew Cab)
Rapid-heat supplemental cab heater² (diesel engine; standard where required)
Rear-window defroster
Upfitter switches, 6 located in overhead console²
Vehicle Safe^{2,4}

EXTERIOR

Bed mat²
Bedliner – Drop-in²
Bedliner – Tough Bed® spray-in with tailgate guard
Black molded hood deflector
Cab steps – 6" chrome angular step bars (SuperCab/Crew Cab)
Cab steps – Black platform running boards (SRW)
Cab steps – Extended-length 6" chrome angular step bars (SuperCab/Crew Cab)
Camera – Customer-placed trailer camera²
Camera – Rear CHMSL camera²
Camera – Rear view camera and prep kit (requires pickup box delete)
Camera – Ultimate Trailer Tow Camera System² (includes trailer hook-up lamp, 360-degree camera with Split-View Display, rear CHMSL camera with LED CHMSL, and Trailer Reverse Guidance)
Exterior backup alarm⁴
Individual Trailer Tire Pressure Monitoring System (TPMS)²
LED box lighting with LED CHMSL
LED roof marker/clearance lamps (SRW)
LED warning strobes^{2,4}
PowerScope® power-telescoping/-folding trailer tow mirrors with high-intensity LED security approach lamps, and LED sideview mirror spotlights
Remote Start System
Skid plates (4x4)
Splash guards, molded² (SRW)
Stowable bed extender² (SRW)
Stowable loading ramps²
Tailgate step with grab bar and tailgate lift assist
Toolbox – Aluminum crossbed by WEATHER GUARD®⁴
Toolbox – Premium aluminum crossbed by WEATHER GUARD⁴
Twin-panel moonroof² (Crew Cab)
Wheel-well liners²

TECHNOLOGY

BLIS® (Blind Spot Information System) with trailer coverage and cross-traffic alert
Fleet telematics modem^{2,5}
FordPass™ Connect^{2,6} embedded 4G LTE modem powered by FordPass app⁶ (includes Wi-Fi hotspot capability)
Reverse Sensing System
SYNC 3² with 8" color LCD capacitive touchscreen in center stack, 911 Assist®, AppLink®, Apple CarPlay™ compatibility, Android Auto™ compatibility, and 2 smart-charging USB ports

PACKAGES

XLT Premium Package² (SuperCab/Crew Cab): chrome tow hooks, mirror caps, door and tailgate handles, and exhaust tip; halogen fog lamps; SecuriCode™ keyless entry keypad; 6" chrome angular step bars; 18" chrome-like PVD wheels (SRW only); SYNC 3; power-adjustable pedals; 8-way power driver's seat with heat; 2-way manual passenger seat with heat; and Reverse Sensing System
XLT Value Package²: halogen fog lamps, SecuriCode keyless entry keypad, power-adjustable pedals (SuperCab/Crew Cab), 8-way power driver's seat, and Reverse Sensing System

Capability Packages: content can be found following the LIMITED pages

LARIAT

4x2 | STANDARD

4x4 | AVAILABLE

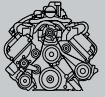

6.2L 2-VALVE GAS
V8 FFV

STANDARD: F-250, F-350

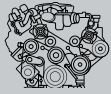

6.7L POWER STROKE®
V8 TURBO DIESEL

STANDARD: F-450
AVAILABLE: F-250, F-350

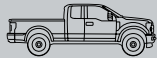

SUPERCAB | 6.75' BOX
F-250 SRW, F-350 SRW

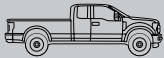

SUPERCAB | 8' BOX
F-250 SRW, F-350 SRW,
F-350 DRW

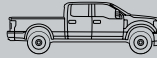

CREW CAB | 6.75' BOX
F-250 SRW, F-350 SRW

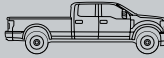

CREW CAB | 8' BOX
F-250 SRW, F-350 SRW,
F-350 DRW, F-450 DRW



40/CONSOLE/40
FRONT BUCKET SEATS
STANDARD



40/20/40
SPLIT FRONT SEATS
AVAILABLE



LARIAT

INCLUDES SELECT XLT FEATURES, PLUS:

SEATING

Leather-trimmed front seating

Front bucket seats and flow-through center console with lockable storage and 2 rear-facing powerpoints

10-way power front seats

Fold-down rear-seat center armrest with dual integrated cupholders (Crew Cab)

Premium vinyl (SuperCab) or leather-trimmed (Crew Cab) rear seating

INTERIOR

B&O PLAY™ Premium Audio System by HARMAN with HD Radio™ MP3 capability, and 10 speakers including subwoofer

8" LCD productivity screen in instrument cluster

110V/400W AC power outlet on instrument panel and rear of center console

Auto-dimming rearview mirror

Dual-zone electronic automatic temperature control

Leather-wrapped steering wheel

Power-adjustable pedals

Power-sliding rear window with defroster

EXTERIOR

6" chrome angular step bars (DRW)

Body-color door handles and chrome tailgate handle

Chrome grille with chrome accents

Halogen fog lamps

PowerScope® power-telescoping/-folding trailer tow mirrors with high-intensity LED security approach lamps, LED sideview mirror spotlights, and body-color mirror caps

SecuriCode™ keyless entry keypad

TECHNOLOGY

FordPass™ Connect¹ embedded 4G LTE modem powered by FordPass app¹ (includes Wi-Fi hotspot capability)

Reverse Sensing System

SYNC® 3 with 8" color LCD capacitive touchscreen in center stack, 911 Assist,® AppLink,® Apple CarPlay™ compatibility, Android Auto™ compatibility, and 2 smart-charging USB ports

AVAILABLE FEATURES AND PACKAGES:

MECHANICAL

750-CCA, 78-amp-hr dual batteries (gas)

Engine block heater

Power takeoff (PTO) provision with transmission-mounted live-drive and stationary modes² (PTO port located on driver's side; split-shaft capability included with diesel engine only; n/a on F-250 with gas engine)

Trailer tow – 5th-wheel hitch²,³ (18,000-lb. rating on SRW, 27,500-lb. rating on DRW)

Trailer tow – Gooseneck dual hitch kit includes one 2 5/16" gooseneck ball, one 3" gooseneck ball, and 2 safety chain tie-down bars²,³ (F-450)

Trailer tow – Gooseneck hitch kit²,³ (F-250/F-350)

Upfitter interface module (Fleet only)

Wheel locks (20" wheels only)

SEATING

40/20/40 split front seat, center under-seat lockable storage with 12V powerpoint, and folding armrest with cupholders and storage

Heated rear outboard seats² (Crew Cab)

INTERIOR

Voice-activated Navigation System² with integrated SiriusXM® Traffic and Travel Link® with 5-year subscription⁴

Flooring – Black vinyl flooring/carpet delete

Flooring – Floor liners²

Inflatable rear safety belts in outboard seating positions² (Crew Cab)

Rapid-heat supplemental cab heater² (diesel engine; standard where required)

Universal garage door opener

Upfitter switches, 6 located in overhead console²

Vehicle Safe²,⁵

EXTERIOR

Bed mat²

Bedliner – Drop-in²

Bedliner – Tough Bed® spray-in with tailgate guard

Black molded hood deflector

Cab steps – 6" chrome angular step bars (SRW)

Cab steps – Extended-length 6" chrome angular step bars

Cab steps – Power-deployable running boards²

Camera – Customer-placed trailer camera²

Camera – Rear CHMSL camera²

Camera – Ultimate Trailer Tow Camera System² (includes trailer hook-up lamp, 360-degree camera with Split-View Display, rear CHMSL camera with LED CHMSL, and Trailer Reverse Guidance)

Exterior backup alarm⁵

Individual Trailer Tire Pressure Monitoring System (TPMS)²

LED box lighting with LED CHMSL

LED roof marker/clearance lamps (SRW)

LED warning strobes²,⁵

Lower-accent two-tone paint (includes accent-color wheel-lip moldings on SRW)

Quad-beam LED headlamps with LED taillamps and LED fog lamps²

Remote Start System

Skid plates (4x4)

Splash guards, molded² (SRW)

Stowable bed extender² (SRW)

Stowable loading ramps²

Tailgate step with grab bar and tailgate lift assist

Toolbox – Aluminum crossbed by WEATHER GUARD®⁵

Toolbox – Premium aluminum crossbed by WEATHER GUARD⁵

Twin-panel moonroof² (Crew Cab)

Wheel-well liners²

TECHNOLOGY

Adaptive cruise control & forward collision warning with brake support²

Adaptive steering

BLIS® (Blind Spot Information System) with trailer coverage and cross-traffic alert

PACKAGES

Chrome Package:² 6" chrome angular step bars; 18" chrome-like PVD wheels (SRW); chrome tow hooks, mirror caps, door and tailgate handles, and exhaust tip

LARIAT Ultimate Package (Crew Cab): auto high-beam headlamps, rain-sensing windshield wipers, memory feature for sideview mirrors, LED CHMSL, LED box lighting, remote tailgate release, tailgate step, Remote Start System, Intelligent Access with push-button start, heated steering wheel, power-tilt/-telescoping steering column with memory, ambient lighting, heated and cooled front seats, easy-entry/-exit driver's seat with memory, power-adjustable pedals with memory, and voice-activated Navigation System with integrated SiriusXM Traffic and Travel Link with 5-year subscription⁴

LARIAT Value Package:² memory feature for sideview mirrors, LED CHMSL, LED box lighting, Remote Start System, heated and cooled front seats, easy-entry/-exit driver's seat with memory, and power-adjustable pedals with memory

Sport Package:² (Crew Cab SRW 4x4): 6" black-painted angular running boards; 20" premium black-painted aluminum wheels with LT275/65R20E OWL all-season tires; Agate Black-painted grille, mirror caps and fender vent surrounds; blacked-out headlamp surrounds (halogen headlamps only); body-color bumpers; Tough Bed spray-in bedliner; and rear wheel-well liners

Tow Technology Bundle: adaptive steering, auto high-beam headlamps, rain-sensing windshield wipers, lane-keeping alert, Driver Alert System, and Ultimate Trailer Tow Camera System

Capability Packages: content can be found following the LIMITED pages

KING RANCH®

4x2 | STANDARD

4x4 | AVAILABLE

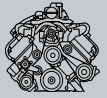

6.2L 2-VALVE GAS V8 FFV
STANDARD: F-250, F-350

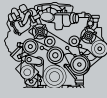

6.7L POWER STROKE® V8
TURBO DIESEL
STANDARD: F-450
AVAILABLE: F-250, F-350

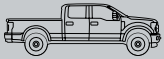

CREW CAB | 6.75' BOX
F-250 SRW, F-350 SRW

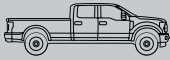

CREW CAB | 8' BOX
F-250 SRW, F-350 SRW,
F-350 DRW, F-450 DRW



40/CONSOLE/40
FRONT BUCKET SEATS
STANDARD



KING RANCH®

INCLUDES SELECT LARIAT FEATURES, PLUS:

SEATING

Easy-entry/-exit driver's seat feature with memory
Heated and cooled front seats

INTERIOR

Voice-activated Navigation System with integrated SiriusXM® Traffic and Travel Link® with 5-year subscription¹
Heated steering wheel
Ice Blue ambient lighting
Intelligent Access with push-button start
Power-adjustable pedals with memory
Power-tilt/-telescoping steering column with memory
Universal garage door opener

EXTERIOR

Chrome grille with Caribou accents
LED box lighting with LED CHMSL
Lower-accent Stone Gray paint (includes Stone Gray wheel-lip moldings on SRW)
Memory feature for sideview mirrors
Remote tailgate release with power remote lock
Remote Start System
Stone Gray angular step bars with lights
Stone Gray-painted steel bumpers

TECHNOLOGY

Automatic high-beam headlamps
Rain-sensing windshield wipers

AVAILABLE FEATURES AND PACKAGES:

MECHANICAL

750-CCA, 78-amp-hr dual batteries (gas)
Engine block heater
Power takeoff (PTO) provision with transmission-mounted live-drive and stationary modes² (PTO port located on driver's side; split-shaft capability included with diesel engine only; n/a on F-250 with gas engine)
Trailer tow – 5th-wheel hitch^{2,3} (18,000-lb. rating on SRW, 27,500-lb. rating on DRW)
Trailer tow – Gooseneck dual hitch kit includes one 2 5/16" gooseneck ball, one 3" gooseneck ball, and 2 safety chain tie-down bars^{2,3} (F-450)
Trailer tow – Gooseneck hitch kit^{2,3} (F-250/F-350)
Upfitter interface module (Fleet only)
Wheel locks (20" wheels only)

SEATING

Heated rear outboard seats

INTERIOR

Flooring – Floor liners
Flooring – Premium vinyl flooring with front and rear carpeted floor mats and floor liners
Inflatable rear safety belts in outboard seating positions
Rapid-heat supplemental cab heater² (diesel engine; standard where required)
Upfitter switches, 6 located in overhead console²
Vehicle Safe^{2,4}

EXTERIOR

Bed mat²
Bedliner – Drop-in²
Bedliner – Tough Bed® spray-in with tailgate guard
Black molded hood deflector
Cab steps – Extended-length 6" chrome angular step bars
Cab steps – Power-deployable running boards
Camera – Customer-placed trailer camera²
Camera – Rear CHMSL camera²
Camera – Ultimate Trailer Tow Camera System² (includes trailer hook-up lamp, 360-degree camera with Split-View Display, rear CHMSL camera with LED CHMSL, and Trailer Reverse Guidance)
Exterior backup alarm⁴
Individual Trailer Tire Pressure Monitoring System (TPMS)²
LED roof marker/clearance lamps (SRW)
Quad-beam LED headlamps with LED taillamps and LED fog lamps²
Skid plates (4x4)
Splash guards, molded² (SRW)
Stowable bed extender² (SRW)
Stowable loading ramps²
Tailgate step with grab bar and tailgate lift assist
Toolbox – Aluminum crossbed by WEATHER GUARD®⁴
Toolbox – Premium aluminum crossbed by WEATHER GUARD⁴
Twin-panel moonroof² (Crew Cab)
Wheel-well liners²

TECHNOLOGY

Adaptive cruise control & forward collision warning with brake support
Adaptive steering
BLIS® (Blind Spot Information System) with trailer coverage and cross-traffic alert

PACKAGES

Chrome Package:² 6" chrome angular step bars; 18" chrome-like PVD wheels (SRW only); chrome tow hooks, mirror caps, door and tailgate handles, and exhaust tip; chrome front and rear bumpers, chrome tailgate appliqué

KING RANCH Monochromatic Paint Package:² monochromatic paint; deletes two-tone lower accent color and Stone Gray wheel-lip moldings; requires Chrome Package

KING RANCH Ultimate Package: BLIS (Blind Spot Information System) with trailer coverage and cross-traffic alert; quad-beam LED headlamps; LED taillamps; LED fog lamps, and; twin-panel moonroof; tailgate step; power-deployable running boards; and multicontour front bucket seats with Active Motion®

Tow Technology Bundle: adaptive steering, auto high-beam headlamps, rain-sensing windshield wipers, lane-keeping alert, Driver Alert System, and Ultimate Trailer Tow Camera System

Capability Packages: content can be found following the LIMITED pages



PLATINUM

4x4 | STANDARD

4x2 | AVAILABLE (DRW ONLY)

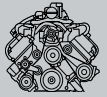

6.2L 2-VALVE GAS V8 FFV
STANDARD: F-250, F-350

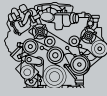

6.7L POWER STROKE® V8
TURBO DIESEL
STANDARD: F-450
AVAILABLE: F-250, F-350

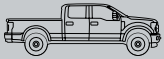

CREW CAB | 6.75' BOX
F-250 SRW, F-350 SRW

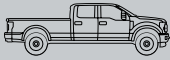

CREW CAB | 8' BOX
F-250 SRW, F-350 SRW,
F-350 DRW, F-450 DRW



40/CONSOLE/40
FRONT BUCKET SEATS
STANDARD



PLATINUM

INCLUDES SELECT LARIAT FEATURES, PLUS:

SEATING

Multicontour front bucket seats with Active Motion®
Easy-entry/-exit driver's seat feature with memory
Heated and cooled front seats
Heated rear outboard seats

INTERIOR

Voice-activated Navigation System with integrated SiriusXM® Traffic and Travel Link® with 5-year subscription¹
Heated steering wheel
Ice Blue ambient lighting
Intelligent Access with push-button start
Power-adjustable pedals with memory
Power-tilt/-telescoping steering column with memory
Universal garage door opener

EXTERIOR

Body-color-painted steel bumpers
Chrome door and tailgate handles
Chrome exhaust tip
Chrome front tow hooks
Chrome sideview mirror caps
LED box lighting with LED CHMSL
LED fog lamps
LED taillamps
Memory feature for sideview mirrors
Power-deployable running boards
Quad-beam LED headlamps
Remote tailgate release with power remote lock
Remote Start System
Satin-aluminum grille
Satin-aluminum tailgate appliqué
Splash guards (DRW)
Tailgate step with grab bar and tailgate lift assist

TECHNOLOGY

Adaptive steering
Automatic high-beam headlamps
BLIS® (Blind Spot Information System) with trailer coverage and cross-traffic alert
Rain-sensing windshield wipers

AVAILABLE FEATURES AND PACKAGES:

MECHANICAL

750-CCA, 78-amp-hr dual batteries (gas)
Engine block heater
Power takeoff (PTO) provision with transmission-mounted live-drive and stationary modes² (PTO port located on driver's side; split-shaft capability included with diesel engine only; n/a on F-250 with gas engine)
Trailer tow – 5th-wheel hitch²³ (18,000-lb. rating on SRW, 27,500-lb. rating on DRW)
Trailer tow – Gooseneck dual hitch kit includes one 2 5/16" gooseneck ball, one 3" gooseneck ball, and 2 safety chain tie-down bars².³ (F-450)
Trailer tow – Gooseneck hitch kit².³ (F-250/F-350)
Upfitter interface module (Fleet only)
Wheel locks (20" wheels only)

INTERIOR

Flooring – Floor liners
Flooring – Premium vinyl flooring with front and rear carpeted floor mats and floor liners
Inflatable rear safety belts in outboard seating positions
Rapid-heat supplemental cab heater (diesel engine; standard where required)
Upfitter switches, 6 located in overhead console²
Vehicle Safe⁴

EXTERIOR

Bed mat²
Bedliner – Drop-in²
Bedliner – Tough Bed® spray-in with tailgate guard
Black molded hood deflector
Camera – Customer-placed trailer camera²
Camera – Rear CHMSL camera²
Camera – Ultimate Trailer Tow Camera System² (includes trailer hook-up lamp, 360-degree camera with Split-View Display, rear CHMSL camera with LED CHMSL, and Trailer Reverse Guidance)
Exterior backup alarm⁴
Individual Trailer Tire Pressure Monitoring System (TPMS)²
LED roof marker/clearance lamps (SRW)
Skid plates (4x4)
Splash guards, molded² (SRW)
Stowable bed extender² (SRW)
Stowable loading ramps²
Toolbox – Aluminum crossbed by WEATHER GUARD®⁴
Toolbox – Premium aluminum crossbed by WEATHER GUARD⁴
Twin-panel moonroof² (Crew Cab)
Wheel-well liners²

TECHNOLOGY

Adaptive cruise control & forward collision warning with brake support

PACKAGES

PLATINUM Ultimate Package: adaptive cruise control & forward collision warning with brake support, lane-keeping alert, Driver Alert System, twin-panel moonroof, and Ultimate Trailer Tow Camera System

Capability Packages: content can be found following the LIMITED pages



LIMITED

4x4 | STANDARD

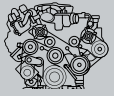

**6.7L POWER STROKE® V8
TURBO DIESEL**

STANDARD: F-250, F-350, F-450

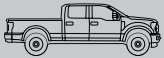

CREW CAB | 6.75' BOX
F-250 SRW, F-350 SRW

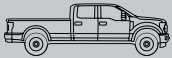

CREW CAB | 8' BOX
F-250 SRW, F-350 SRW,
F-350 DRW, F-450 DRW



**40/CONSOLE/40
FRONT BUCKET SEATS**
STANDARD



LIMITED

INCLUDES SELECT LARIAT FEATURES, PLUS:

MECHANICAL

750-CCA, 78-amp-hr dual batteries

SEATING

Multicontour front bucket seats with Active Motion®

Easy-entry/-exit driver's seat feature with memory

Heated and cooled front seats

Heated rear outboard seats

INTERIOR

Voice-activated Navigation System with integrated SiriusXM® Traffic and Travel Link® with 5-year subscription¹

Heated steering wheel

Ice Blue ambient lighting

Illuminated door-sill scuff plates

Intelligent Access with push-button start

Power-adjustable pedals with memory

Power-tilt/-telescoping steering column with memory

Universal garage door opener

Upfitter switches, 6 located in overhead console

EXTERIOR

Body-color-painted steel bumpers

Chrome exhaust tip

Chrome front tow hooks

LED box lighting with LED CHMSL

LED fog lamps

Memory feature for sideview mirrors

Power-deployable running boards

Quad-beam LED headlamps with LED taillamps

Remote release tailgate with power remote lock

Remote Start System

Satin-aluminum and chrome grille

Satin-aluminum door and tailgate handles

Satin-aluminum tailgate appliqué

Splash guards (DRW)

Tailgate step with grab bar and tailgate lift assist

Twin-panel moonroof² (Crew Cab)

Ultimate Trailer Tow Camera System (includes trailer hook-up lamp, 360-degree camera with Split-View Display, rear CHMSL camera with LED CHMSL, and Trailer Reverse Guidance)

TECHNOLOGY

Adaptive cruise control & forward collision warning with brake support

Adaptive steering

Automatic high-beam headlamps

BLIS® (Blind Spot Information System) with trailer coverage and cross-traffic alert

Lane-keeping alert

Rain-sensing windshield wipers

AVAILABLE FEATURES AND PACKAGES:

MECHANICAL

Engine block heater

Power takeoff (PTO) provision with transmission-mounted live-drive and stationary modes² (PTO port located on driver's side; split-shaft capability included)

Trailer tow – 5th-wheel hitch²,³ (18,000-lb. rating on SRW, 27,500-lb. rating on DRW)

Trailer tow – Gooseneck dual hitch kit includes one 2 5/16" gooseneck ball, one 3" gooseneck ball, and 2 safety chain tie-down bars²,³ (F-450)

Trailer tow – Gooseneck hitch kit²,³ (F-250/F-350)

Upfitter interface module (Fleet only)

Wheel locks (20" wheels only)

INTERIOR

Flooring – Floor liners

Flooring – Premium vinyl flooring with front and rear carpeted floor mats and floor liners

Inflatable rear safety belts in outboard seating positions

Rapid-heat supplemental cab heater (standard where required)

Vehicle Safe²,⁴

EXTERIOR

Bed mat²

Bedliner – Drop-in²

Bedliner – Tough Bed® spray-in with tailgate guard

Black molded hood deflector

Camera – Customer-placed trailer camera²

Exterior backup alarm⁴

Individual Trailer Tire Pressure Monitoring System (TPMS)²

LED roof marker/clearance lamps (SRW)

Skid plates

Splash guards, molded² (SRW)

Stowable bed extender² (SRW)

Stowable loading ramps²

Toolbox – Aluminum crossbed by WEATHER GUARD®⁴

Toolbox – Premium aluminum crossbed by WEATHER GUARD⁴

Wheel-well liners²

PACKAGES

Capability Packages: content can be found on the following pages



CAPABILITY PACKAGES

CAMPER PACKAGE:¹ front springs upgrade (unless maximum springs have been computer-selected as included equipment), rear stabilizer bar (SRW), auxiliary rear springs (F-250), and slide-in camper certification

○ XL, XLT, LARIAT, KING RANCH®

CNG/PROPANE GASEOUS ENGINE PREP PACKAGE (F-250/F-350 gas engine): hardened engine intake valves and valve seats and bi-fuel manifold

○ XL, XLT, LARIAT, KING RANCH, PLATINUM

PICKUP BOX DELETE¹ (F-250/F-350 with 8' box only): deletes pickup box, tailgate, rear bumper, 7-/4-pin connector, CHMSL with cargo lamp, jack, spare wheel, tire, lock, carrier, and rear view camera (rear view camera and prep kit is available)

○ XL, XLT

HEAVY-SERVICE FRONT SUSPENSION PACKAGE FOR PICKUP BOX DELETE¹ (SRW with pickup box delete): front springs upgrade (unless maximum springs have been computer-selected as included equipment), rear auxiliary springs (F-250), and rear stabilizer bar

○ XL, XLT

SNOW PLOW/CAMPER PACKAGE¹ (4x4): computer-selected front springs for snow plow application, extra-heavy-duty alternator, rear stabilizer bar (SRW), auxiliary rear springs (F-250), and slide-in camper certification

○ XL, XLT, LARIAT, KING RANCH

9,900-LB. GVWR PACKAGE¹ (F-250)

10,000-LB. GVWR PACKAGE¹ (F-350 SRW)

11,400-LB. GVWR PACKAGE¹ (F-350 SRW)

13,000-LB. GVWR PACKAGE¹ (F-350 DRW)

5TH-WHEEL/GOOSENECK TRAILER TOW PREP PACKAGE:¹ 1 under-bed frame crossmember, 5 pickup bed 5th-wheel/gooseneck attachment points and close-out plugs, and an integrated 7-pin connector on the driver's side pickup bed wall

F-250 HIGH-CAPACITY TRAILER TOW PACKAGE¹ (F-250 with diesel engine): 3.0" trailer hitch receiver, max. front springs, upgraded axles and 25,700-lb. GCWR

FX4 OFF-ROAD PACKAGE¹ (4x4): Hill Descent Control,[™] off-road-tuned shocks, skid plates for transfer case and fuel tank, and FX4 Off-Road box decals

HEAVY-SERVICE FRONT SUSPENSION PACKAGE:¹ front springs upgrade (unless maximum springs have been computer-selected as included equipment)

SNOW PLOW PREP PACKAGE¹ (4x4): computer-selected springs for snow plow application, and extra-heavy-duty alternator

● ALL TRIMS



● STANDARD ○ AVAILABLE

2019 Super Duty® | ford.com

F-250 XLT Crew Cab 4x4. Magnetic. XLT Premium Package. Available equipment. ¹Restrictions may apply. See your dealer for details.



WHEELS/SRW

● XL



17" Argent-Painted Steel with Painted Center Cap

○ XL



18" Argent-Painted Steel with Painted Center Cap (F-350)

● XLT ○ XL



18" Cast-Aluminum with Bright Center Cap¹ (included in STX Appearance Package)

○ XLT, LARIAT



18" Chrome-Like PVD with Bright Center Cap¹ (included in Chrome Package)

● LARIAT



18" Bright-Machined Cast-Aluminum with Bright Center Cap

○ LARIAT



20" Premium Cast-Aluminum with Bright Center Cap (4x4)

○ LARIAT



20" Chrome-Like PVD with Bright Center Cap¹ (4x4 with Chrome Package)

○ LARIAT



20" Chrome-Like PVD with Bright Center Cap¹ (4x4 with diesel engine and Chrome Package)

○ LARIAT



20" Premium Black-Painted Aluminum (included in Sport Package)

● KING RANCH®



18" Bright-Machined Cast-Aluminum with KING RANCH Center Cap (4x4)

○ KING RANCH



18" Chrome-Like PVD with KING RANCH Center Cap (included in Chrome Package)

○ KING RANCH



20" Premium Painted Cast-Aluminum with KING RANCH Center Cap (4x4)

○ KING RANCH



20" Chrome-Like PVD with KING RANCH Center Cap¹ (4x4 with Chrome Package)

○ KING RANCH



20" Chrome-Like PVD with KING RANCH Center Cap¹ (4x4 with diesel engine and Chrome Package)

● PLATINUM



20" Polished Aluminum with Bright Center Cap

● LIMITED



20" Polished Aluminum with Bright Center Cap

● STANDARD ○ AVAILABLE

WHEELS/DRW

● XL, XLT



17" Argent-Painted Steel without Center Cap (F-350)

○ XL, XLT



17" Stainless Steel Covers, Front and Rear¹ (F-350)

● LARIAT, PLATINUM, LIMITED ○ XL, XLT



17" Polished Forged-Aluminum with Bright Center Cap² (F-350)

● KING RANCH®



17" Polished Forged-Aluminum with KING RANCH Center Cap² (F-350)

● XL, XLT, LARIAT, PLATINUM, LIMITED



19.5" Polished Forged-Aluminum with Bright Center Cap² (F-450)

● KING RANCH



19.5" Polished Forged-Aluminum with KING RANCH Center Cap² (F-450)

TIRES

SRW

- LT245/75R17E BSW All-Season
 - XL
- LT245/75R17E BSW All-Terrain
 - XL
- LT265/70R17E OWL All-Terrain
 - XL
- LT275/65R18E BSW All-Season¹
 - XLT, LARIAT, KING RANCH
 - XL
- LT275/70R18E BSW All-Terrain¹ (4x4)
 - XL, XLT, LARIAT, KING RANCH
- LT275/70R18E OWL All-Terrain (4x4)
 - XL, XLT, LARIAT, KING RANCH
- LT275/65R20E OWL All-Season (4x4)
 - LARIAT, KING RANCH, PLATINUM
- LT275/65R20E OWL All-Terrain (4x4)
 - PLATINUM, LIMITED
 - LARIAT, KING RANCH

DRW

- LT245/75R17E BSW All-Season (F-350)
 - ALL TRIMS
- LT245/75R17E BSW All-Terrain (F-350)
 - ALL TRIMS
- LT245/75R17E OWL All-Terrain (F-350; BSW rear inner tires)
 - XLT, LARIAT, KING RANCH, PLATINUM, LIMITED
- 225/70R19.5G BSW All-Position (F-450)
 - ALL TRIMS

● STANDARD ○ AVAILABLE



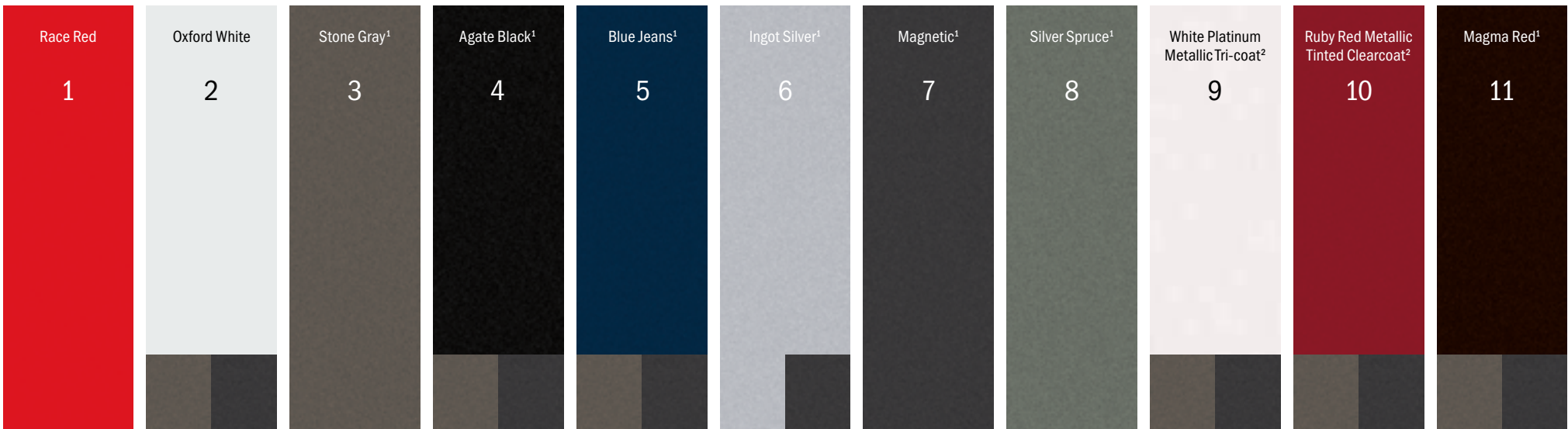

ENGINES

	6.7L Power Stroke® V8 Turbo Diesel	6.2L 2-Valve Gas V8 FFV
Horsepower	450 hp @ 2,800 rpm	385 hp @ 5,750 rpm
Torque	935 lb.-ft. @ 1,800 rpm	430 lb.-ft. @ 3,800 rpm
Configuration	OHV (32-valve)	SOHC
Electronic fuel injection	High-pressure common-rail	Sequential multi-port
Induction system	Single-sequential turbocharger; charged air cooler	Specially tuned
Block material	Compacted graphite iron	Cast iron
Valve operation	Push rod/rocker arms	Roller-rocker shafts
Camshaft drive	Gear	Silent chain
Compression ratio	16.2:1	9.8:1
Recommended fuel	Ultra-low-sulfur diesel or B20 (containing 20% or less biodiesel)	Regular unleaded or E85; bi-fuel-capable CNG or propane autogas (requires upfit)
Transmission	TorqShift® 6-speed SelectShift® automatic with tow/haul mode	TorqShift-G 6-speed SelectShift automatic with tow/haul mode (F-250) TorqShift 6-speed SelectShift automatic with tow/haul mode (F-350)
Standard	F-250/F-350: LIMITED F-450: ALL TRIMS	F-250/F-350: XL, XLT, LARIAT, KING RANCH® PLATINUM
Available	F-250/F-350: XL, XLT, LARIAT, KING RANCH, PLATINUM	

REAR AXLES

	Engine	Standard	Available
F-250/ F-350 SRW	6.2L Gas	3.73 non-limited-slip	3.73 electronic-locking 4.30 electronic-locking
	6.7L Diesel	3.31 non-limited-slip	3.55 non-limited-slip (std. on 4x4 with 20" wheels) 3.55 limited-slip (4x4 only) 3.31 electronic-locking 3.55 electronic-locking (4x4 only)
F-350 DRW	6.2L Gas	3.73 non-limited-slip	3.73 limited-slip 4.30 limited-slip
	6.7L Diesel	3.55 non-limited-slip	3.55 limited-slip 4.10 limited-slip
F-450 DRW	6.7L Diesel	4.30 limited-slip	

PAYLOAD

Maximum Payload Weight Ratings (lbs.)

	Max. GVWR	Regular Cab	SuperCab	Crew Cab		
		141.6" WB	148.0" WB	164.2" WB	159.8" WB	176.0" WB
F-250 SRW 4x2	9,900 10,000	4,170 4,270	3,890 3,990	3,780 3,880	3,790 3,890	3,560 3,660
F-250 SRW 4x4	9,900 10,000	3,740 3,840	3,470 3,570	3,380 3,480	3,380 3,480	3,130 3,230
F-350 SRW 4x2	10,000 10,100 10,300 10,400 10,500 10,600 10,800 10,900 11,000 11,100 11,200 11,300 11,400 11,500	4,080 — — 4,420 — 3,940 — — — 4,380 — — — —	3,820 — — — 4,260 — 3,910 — — — 4,250 — — —	3,710 — 4,010 — — — 4,450 — 3,980 — — — 4,320 4,420	3,660 3,760 — — — 4,200 — 3,820 — — 4,170 — — —	3,430 — — — 3,930 — — 4,280 — 3,780 — — 4,030 4,130
F-350 SRW 4x4	10,000 10,300 10,400 10,500 10,700 10,800 10,900 11,000 11,100 11,200 11,300 11,400 11,500	3,660 3,960 — — — 4,400 — 3,920 — — 4,890 4,260 4,360	3,400 — 3,800 — — 4,140 — — 3,790 — 4,640 4,030 4,130	3,290 — — — 3,990 — — — — 4,430 3,860 4,630 4,730	3,250 — — 3,750 — — 4,090 — — 3,710 4,480 3,850 3,950	3,010 — — — — 3,810 — — — — 4,250 4,350 4,450
F-350 DRW 4x4	13,000 14,000	6,640 7,640	— —	6,200 7,200	— —	5,970 6,970
F-350 DRW 4x4	13,000 14,000	6,230 7,230	— —	5,780 6,780	— —	5,550 6,550
F-450 DRW 4x2	14,000	6,190	—	—	—	5,630
F-450 DRW 4x4	14,000	5,880	—	—	—	5,310

Best-in-class configuration shown bolded and in color.



TOWING

Maximum Loaded Trailer Weight Ratings (lbs.) – SAEJ2807 Compliant

	Engine	Axle Ratio	GCWR	Regular Cab Conventional Towing			SuperCab Conventional Towing			Crew Cab Conventional Towing		
				Weight Carrying	Weight Distribution	5th-Wheel/ Gooseneck Towing	Weight Carrying	Weight Distribution	5th-Wheel/ Gooseneck Towing	Weight Carrying	Weight Distribution	5th-Wheel/ Gooseneck Towing
F-250 SRW 4x2	6.2L Gas	3.73	19,500	13,000	13,300	13,300	13,000	13,000	13,000	12,900	12,900	12,900
		4.30	22,000	13,000	14,000	15,800	14,000	15,000	15,500	14,000	15,000	15,400
	6.7L Diesel	3.31/3.55	24,100	–	–	–	–	–	–	–	–	16,600 ¹
			24,700 25,700	14,000 ¹	15,000 ¹	18,500 ¹	15,000 ¹	15,000 ¹	17,300 ¹	18,000 ¹	18,000 ¹	–
F-250 SRW 4x4	6.2L Gas	3.73	19,500	12,900	12,900	12,800	12,600	12,600	12,600	12,500	12,500	12,500
		4.30	22,000	15,000	15,000	15,300	15,000	15,000	15,100	15,000	15,000	15,000
	6.7L Diesel	3.31/3.55	22,500	–	–	–	–	–	–	–	–	14,700
			22,900 23,100 24,400 25,200 25,700	–	–	–	14,000	15,000	14,800 ¹ 15,400	–	–	–
F-350 SRW 4x2	6.2L Gas	3.73	19,500	13,000	13,100	13,100	12,900	12,900	12,800	12,700	12,700	12,700
		4.30	23,000	13,000	14,000	16,600	13,000	14,000	16,300	15,000	15,000	16,200
	6.7L Diesel	3.31/3.55	28,700	14,000	15,000	21,500 ²	15,000	15,000	21,300 ²	18,000	18,000	21,100 ²
F-350 SRW 4x4	6.2L Gas	3.73	19,500	12,700	12,700	12,700	12,400	12,400	12,400	12,300	12,300	12,200
		4.30	23,000	15,000	15,000	16,200	15,000	15,000	15,900	15,000	15,000	15,700
	6.7L Diesel	3.31/3.55	28,700	14,000	15,000	21,100 ²	15,000	15,000	20,900 ²	18,000	18,000	20,700 ²
F-350 DRW 4x2	6.2L Gas	3.73	20,000	13,200	13,200	13,100	12,700	12,700	12,700	12,500	12,500	12,500
		4.30	23,500	16,700	16,700	16,600	16,200	16,200	16,200	16,000	16,000	16,000
	6.7L Diesel	3.55	36,000	18,000	21,000	28,400 ³	18,000	21,000	28,000 ³	19,000	21,000	27,800 ³
		4.10	40,000	18,000	21,000	32,000 ³	18,000	21,000	32,000 ³	19,000	21,000	31,800 ³
F-350 DRW 4x4	6.2L Gas	3.73	20,000	12,800	12,800	12,700	12,300	12,300	12,300	12,100	12,100	12,100
		4.30	23,500	16,300	16,300	16,200	15,800	15,800	15,800	15,600	15,600	15,600
	6.7L Diesel	3.55	36,000	18,000	20,000	28,000 ³	19,000	21,000	27,600 ³	21,000	21,000	27,300
		4.10	40,000	18,000	20,000	32,000 ³	19,000	21,000	31,600 ³	21,000	21,000	31,300 ³
F-450 DRW 4x2	6.7L Diesel	4.30	42,800 43,300	– 21,000	– 21,000⁴	– 35,000³	– –	– –	– –	21,000 –	21,000 –	34,000 ³ –
F-450 DRW 4x4	6.7L Diesel	4.30	41,700 43,300	– 21,000	– 21,000⁴	– 34,700 ³	– –	– –	– –	21,000 –	21,000 –	32,500 ³ –

Best-in-class configurations shown bolded and in color.

2019 Super Duty® | ford.com

SRW = single rear wheel DRW = dual rear wheel WB = wheelbase SWB = short wheelbase (6.75' cargo box) LWB = long wheelbase (8' cargo box) ¹Requires F-250 High-Capacity Trailer Tow Package. ²Gooseneck tow rating shown. 5th-wheel tow rating limited to 5th-wheel hitch rating of 18,000 lbs. ³Gooseneck tow rating shown. 5th-wheel tow rating limited to 5th-wheel hitch rating of 27,500 lbs. ⁴25% Weight Distribution setup required.

Maximum capabilities shown are for properly equipped vehicles with required equipment and a 150-lb. driver. Weight of additional options, equipment, passengers and cargo must be deducted from this weight. For additional information, see your Ford Dealer. **Conventional/Gooseneck Towing Notes:** This information also applies to models with Pickup box delete option (66D). Trailer tongue load weight should be 10% of total loaded trailer weight. Make sure that the vehicle payload (reduced by option weight) will accommodate trailer tongue load weight and the weight of passengers and cargo added to the towing vehicle. The addition of trailer tongue load weight, and the weight of passengers and cargo, must not cause vehicle weights to exceed the rear GAWR (Gross Axle Weight Rating) or GVWR (Gross Vehicle Weight Rating). These ratings can be found on the vehicle's Safety Compliance Certification Label.

5th-Wheel Towing Notes: This information also applies to models with pickup box delete option (66D). Trailer king pin load weight should be 15% of total loaded trailer weight. Make sure that the vehicle payload (reduced by option weight) will accommodate trailer king pin load weight and the weight of passengers and cargo added to the towing vehicle. The addition of trailer king pin load weight, and the weight of passengers and cargo, must not cause vehicle weights to exceed the rear GAWR (Gross Axle Weight Rating) or GVWR (Gross Vehicle Weight Rating). These ratings can be found on the vehicle's Safety Compliance Certification Label.



DIMENSIONS

EXTERIOR	Regular Cab	SuperCab		Crew Cab	
	8' Box 4x2/4x4	6.75' Box 4x2/4x4	8' Box 4x2/4x4	6.75' Box 4x2/4x4	8' Box 4x2/4x4
Wheelbase	141.6"	148.0"	164.2"	159.8"	176.0"
Length	231.8"	238.2"	254.4"	250.0"	266.2"
Width					
SRW (excl. mirrors)	80.0"	80.0"	80.0"	80.0"	80.0"
DRW (excl. mirrors)	96.0"	—	96.0"	—	96.0"
With mirrors	105.9"	105.9"	105.9"	105.9"	105.9"
With mirrors extended	110.0"	110.0"	110.0"	110.0"	110.0"
Height					
F-250 SRW (w/o options)	78.5"/81.9"	78.7"/81.8"	78.4"/81.7"	78.6"/81.9"	78.3"/81.6"
F-350 SRW (w/o options)	78.3"/81.7"	78.5"/81.6"	78.3"/81.5"	78.5"/81.6"	78.0"/81.4"
F-350 DRW (w/o options)	78.8"/81.6"	—	78.4"/81.5"	—	78.5"/81.6"
F-450 DRW (w/o options)	81.7"/81.7"	—	—	—	81.5"/81.5"
Ground clearance					
F-250 SRW	8.7"/8.5"	8.7"/8.5"	8.8"/8.5"	8.8"/8.2"	8.7"/8.5"
F-350 SRW	8.7"/8.5"	8.7"/8.5"	8.8"/8.5"	8.6"/8.5"	8.7"/8.5"
F-350 DRW	8.3"/8.2"	—	8.2"/8.4"	—	8.4"/8.4"
F-450 DRW	8.6"/8.6"	—	—	—	8.6"/8.6"
INTERIOR	Regular Cab	SuperCab	Crew Cab		
Front					
Head room	40.8"	40.8"	40.8"		
Leg room (max.)	43.9"	43.9"	43.9"		
Hip room	62.5"	62.5"	62.5"		
Shoulder room	66.7"	66.7"	66.7"		
Rear					
Head room	—	40.3"	40.4"		
Leg room	—	33.5"	43.6"		
Hip room	—	64.7"	64.7"		
Shoulder room	—	65.8"	65.9"		
Total passenger volume	64.6 cu. ft.	116.0 cu. ft.	131.8 cu. ft.		
Cargo volume behind 1st row	11.6 cu. ft.	31.6 cu. ft.	52.1 cu. ft.		
CARGO BOX	8' Box	6.75' Box			
Volume (cu. ft.)	78.5	65.4			
Length at floor	98.1"	81.9"			
Width at wheelhouse	50.5"	50.5"			
Width at floor (max.)	66.9"	66.9"			
Cargo box height	21.1"	21.1"			

MECHANICAL

Max. Axle Rating @ Ground (lbs.)		Front	Rear	Brakes
F-250 SRW	4x2	5,250 6,000 ¹	6,200 6,200 ¹	Rotor diameter (front/rear) – 14.29"/14.29" (F-250/F-350); 15.39"/15.74" (F-450)
	4x4	6,000	6,200	
F-350 SRW	4x2	5,250 6,000 ¹	7,280 7,280 ¹	
	4x4	6,000	7,280	
F-350 DRW	4x2	5,250	9,650	Wheels
	4x4	6,000	9,650	
F-450 DRW	4x2	7,000	9,650	Number of studs – 8 (F-250/F-350); 10 (F-450)
	4x4	7,000	9,650	
Bolt-circle diameter – 6.69" (170-mm) SRW; 7.87" (200-mm) F-350 DRW; 8.86" (225-mm) F-450				

¹With 3.31 axle delete.

ALTERNATORS

	Engine	Standard	Available
XL, XLT	6.2L Gas	157-amp	200-amp 240-amp
	6.7L Diesel	175-amp	220-amp 332-amp 377-amp
LARIAT, KING RANCH® PLATINUM	6.2L Gas	200-amp	240-amp
	6.7L Diesel	220-amp	332-amp 377-amp
LIMITED	6.7L Diesel	332-amp	377-amp

FUEL CAPACITY

	6.2L Gas Engine	6.7L Diesel Engine
Regular Cab 8' box SuperCab 6.75' box	34-gallon	29-gallon
SuperCab 8' box Crew Cab 6.75' box	34-gallon	34-gallon
Crew Cab 8' box	48-gallon	48-gallon



New Vehicle Limited Warranty. We want your Ford F-Series Super Duty® ownership experience to be the best it can be. Under this warranty, your new vehicle comes with 3-year/36,000-mile bumper-to-bumper coverage, 5-year/60,000-mile Powertrain Warranty coverage, 5-year/60,000-mile safety restraint coverage, and 5-year/unlimited-mile corrosion (perforation) coverage on aluminum body panels – all with no deductible. The Ford 6.7L Power Stroke® diesel engine gets 5-year/100,000-mile warranty coverage. Please ask your Ford Dealer for a copy of this limited warranty.

Roadside Assistance. Covers your vehicle for 5 years or 60,000 miles, so you have the security of knowing that help may be only a phone call away should you run out of fuel, lock yourself out of the vehicle or need towing. Your Ford Dealer can provide complete details on all of these advantages.

Ford Credit. Get the ride you want. Whether you plan to lease or finance, you'll find the choices that are right for you at Ford Credit. Ask your Ford Dealer for details or check us out at fordcredit.com.

Ford Protect™ Extended Service Plans. Whether you purchase or lease your Ford vehicle, insist on genuine Ford Protect extended service plans. Ford Protect has a variety of plans to give you peace-of-mind protection whether you want vehicle component or maintenance coverage. Plus, they are fully backed by Ford and honored at all Ford dealerships in the U.S., Canada and Mexico. When you visit your dealer, insist on genuine Ford Protect extended service plans.

Insurance Services. Get Ford Motor Company quality in your auto insurance. Our program offers industry-leading benefits and competitive rates. Call 1-877-367-3847, or visit us at fordvip.com for a no-obligation quote. Insurance offered by American Road Services Company (in CA, American Road Insurance Agency), a licensed agency and subsidiary of Ford Motor Company.

Ford Original Accessories. They're warranted for whichever provides you the greatest benefit: 24 months/unlimited mileage, or the remainder of your Bumper-to-Bumper 3-year/36,000-mile New Vehicle Limited Warranty. Ford Licensed Accessories (FLA) are warranted by the accessory manufacturer's warranty. FLA are designed and developed by the accessory manufacturer and have not been designed or tested to Ford Motor Company engineering requirements. Contact your Ford Dealer for details and/or a copy of all limited warranties.

Amazon, Alexa, and all related logos are trademarks of Amazon.com, Inc. or its affiliates. Android, Android Auto, Google, Google Maps, Google Play, Waze and logos are trademarks of Google Inc. Apple, Apple CarPlay, Apple Music, iPhone and Siri are trademarks of Apple Inc., registered in the U.S. and other countries. App Store is a service mark of Apple Inc. B&O PLAY is a trademark of HARMAN International Industries, registered in the United States and other countries. "HD Radio" and the HD Radio logo are proprietary trademarks of iBiquity Digital Corporation. King Ranch is a registered trademark of King Ranch, Inc. Miko is a registered trademark of Miko s.r.l. PANDORA, the PANDORA logo, and the Pandora trade dress are trademarks or registered trademarks of Pandora Media, Inc. Used with permission. Sirius, XM, SiriusXM and all related marks and logos are trademarks of Sirius XM Radio Inc. WEATHER GUARD is a registered trademark of Werner Co.

Comparisons based on competitive models (class is Full-Size Pickups over 8,500 lbs. GVWR based on Ford segmentation), publicly available information and Ford certification data at time of release. Vehicles may be shown with optional and aftermarket upfit equipment. Features may be offered only in combination with other options or subject to additional ordering requirements/limitations. Dimensions and capacity ratings shown may vary due to optional features and/or production variability. Information is provided on an "as is" basis and could include technical, typographical or other errors. Ford makes no warranties, representations, or guarantees of any kind, express or implied, including but not limited to, accuracy, currency, or completeness, the operation of the information, materials, content, availability, and products. Ford reserves the right to change product specifications, pricing and equipment at any time without incurring obligations. Your Ford Dealer is the best source of the most up-to-date information on Ford vehicles. Body manufacturers are responsible for compliance certification of the completed vehicle. The Ford New Vehicle Limited Warranty and any government certification made by Ford shall cover only the vehicle as manufactured by Ford and shall not extend to any addition, modification or change of or to the vehicle by the Ford Authorized Pool Account.

ford.com/trucks/superduty

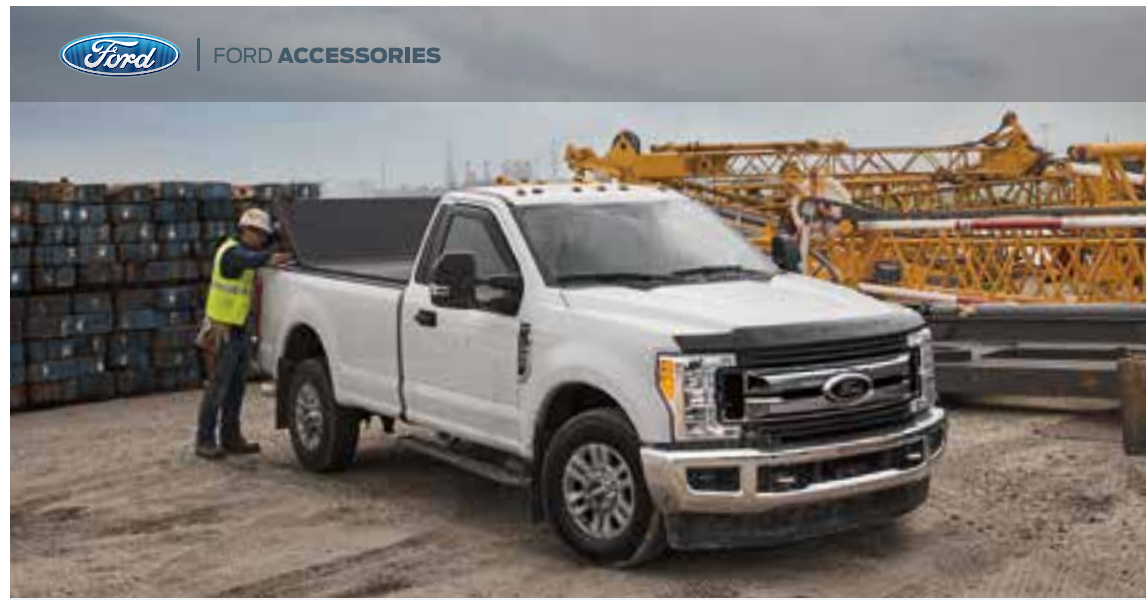

F-250 XLT with XLT Value Package in Oxford White accessorized with 5" black step bars, hood deflector, side window deflectors,¹ hard-folding tonneau cover,¹ heavy-duty splash guards, chrome front tow hooks, LED fog lamps,¹ and rear wheel-well liners



Stowable load ramps



Floor liners



5th-wheel hitch kits



Remote start systems

Shop the complete collection at accessories.ford.com

¹Ford Licensed Accessory.